

# ETAG

European Technology Assessment  
Group

ITAS · DBT · viWTA · POST · Rathenau



## **Sustainable Energy Catalogue - for European Decision-makers**

---

Final report

Deliverable from the project

‘Overview of Sustainable Energy Sources’

commissioned by STOA and carried out by ETAG

Specific Contract No. IP/A/STOA/SC/2005-179

Ref.: Framework Contract IP/STOA/FWC/2005-28

October 2006

Report prepared by

Søren Gram and Søren Jacobsen

The Danish Board of Technology (DBT)

### **European Technology Assessment Group**

- Institute for Technology Assessment and Systems Analysis (ITAS), Karlsruhe
- Danish Board of Technology (DBT), Copenhagen
- Flemish Institute for Science and Technology Assessment (viWTA), Brussels
- Parliamentary Office of Science and Technology (POST), London
- Rathenau Institute, The Hague



## **Document purpose and destination**

This document contains the final delivery of the project “Overview of Sustainable Energy Sources”

It provides an introduction to selected sustainable energy sources and technologies. The contents are the outcome of the work of an interdisciplinary expert working group.

The report draws on discussions from working group meetings in Copenhagen on May 30<sup>th</sup> and September 15<sup>th</sup>. Furthermore the catalogue has been subjected to external evaluation. The project management would like to thank everybody who has contributed to the report.

Responsibility for the text of this document is retained solely by the authors and the opinions expressed therein do **not necessarily represent the position of the European Parliament**. Reproduction and translation of this document or parts of it are limited to its authors, for non commercial purposes and in connection with the above-mentioned project only. Prior authorisation by the European Parliament is required.

## **Project description**

Specific contract no. IP/A/STOA/SC/2005-179

Framework contract no. IP/A/STOA/FWC/2005-28

Project management: The Danish Board of Technology, as member of the ETAG Group.  
Søren Gram, project manager, [sg@tekno.dk](mailto:sg@tekno.dk)  
Søren Jacobsen, project assistant, [sj@tekno.dk](mailto:sj@tekno.dk)  
Teknologirådet (Danish Board of Technology), Antonigade 4, 4., DK-1160 Copenhagen  
Tel.: +45-33320503

Members of the European Parliament in charge: Philippe Busquin, MEP.

STOA staff in charge: Miklos Gyoerffi ([miklos.gyoerffi@europarl.europa.eu](mailto:miklos.gyoerffi@europarl.europa.eu))

Copenhagen, October 2006



## **Executive Summary**

The Green paper - A European Strategy for Sustainable, Competitive and Secure Energy, 2006 – states that Europe has a rising dependency on imported energy reserves, which are concentrated in a few countries. The Rising gas and oil prices along with demands on lower emissions of CO<sub>2</sub> adds pressure on the need for a new energy future for Europe. EU has since 1990 planned to become world leader in the renewable energy field. Therefore the EU member states have agreed that by 2010 21% of the consumed electricity and 5,75% of the consumed gasoline and diesel should originate from renewable energy sources. If the EU countries are to reach their goals, a commitment on several levels to develop and install energy from sustainable energy sources is needed.

The purpose of this catalogue is to offer planners and decision-makers in EU states an inspirational tool to be used during local or regional transition towards sustainable energy technologies. The catalogue can also be used by everyone else who needs an overview of the sustainable energy technologies and their current development level and future potential, among others educational use is relevant.

The catalogue provides an introduction to the following technologies that are already or are estimated to become central to a development with renewable energy in EU: Technologies for wind energy, wave energy, geothermal energy, bioenergy, solar energy, hydropower and fuel cells. The catalogue also includes a section about energy systems, which also includes a part about technologies for efficient use of energy.

The catalogue could have included a few other technologies as e.g. heating pumps, but due to the size of the catalogue a priority was necessary. The catalogue does not claim to give all answers or to be complete regarding all details about the individual technologies; even so it offers information, which cannot easily be looked up on the Internet. In the back of the catalogue, under “References and links” there is a list of contacts, pamphlets, web pages etc., where it is possible to find more information about the individual technologies.

Each chapter offers both an overview of the single technology concerning development stage, best available technology, supply potential, environmental impact etc., a comparison between the different technologies and information about how the technologies can interact with each other and with the energy system. Further more a timeline that spreads towards (further) commercialisation is drawn for each technology. This timeline includes significant events with regard to research and development, the market and policies that are expected to be of importance to the success of the technology.

The text on each technology is written on a background of expert knowledge supplied by a selection of experts on each technology presented in the catalogue. The texts are further more reviewed and evaluated by an external expert. A review is placed in connection with the individual technology.

## Colophon

### **Project management, the Danish Board of Technology:**

Project Manager: **Søren Gram**

Project Assistant: **Søren Jacobsen**

Freelance Journalist: **Jakob Vedelsby**

### **The following experts have supplied expert knowledge:**

The energy system: **Per Nørgård**, Risø Wind Energy Department, Risø National Laboratory, and **Peter Bach**, Chief Adviser on Energy Efficiency, Energistyrelsen (The Danish Energy Authority).

Efficient use of energy: **Peter Bach**, Chairman of European Council for an Energy Efficient Economy (ECEEE), Vice-chairman of IEA Energy Efficiency Working Party, Chief Adviser on Energy Efficiency at The Danish Energy Authority (Energistyrelsen).

Fuel Cells: **Per Nørgård**, Risø Wind Energy Department, Risø National Laboratory

Wind energy: **Flemming Øster**, Risø Wind Turbine Certification Scheme, Risø National Laboratory.

Wave energy: **Kim Nielsen**, Project coordinator for the Coordinated Action on Ocean Energy (CA-OE) project, Rambøll.

Geothermal energy: **Allan Mahler**, Geothermal Engineering Manager, DONG Energy; experience from the establishment and operation of geothermal plants; member of EGEC and IGA.

Bioenergy from biomass: **Henning Jørgensen**, Centre for Forrest, Landscape and Planning, Faculty of Life Sciences, University of Copenhagen, member of IEA Bioenergy task 42 - Biorefineries: Co-production of Fuels, Chemicals, Power and Materials from Biomass.

Solar energy: **Peter Ahm**, P.A. Energy; member of the International Energy Agency (IEA) Photovoltaic Power Systems Programme, The European Photovoltaic Technology Platform and The Photovoltaic European Research Area Network (PV-ERA-NET),

Hydro power: **Thore Jarlset**, Noregs vassdrags- og energidirektorat (NVE) (Norwegian Water Resources and Energy Directorate).

### **External expert commenting by:**

**Satu Helynen**, VTT Technical Research Centre of Finland

# Table of Contents

1. Introduction.....	1
2. Energy systems .....	5
3. Efficient use of energy – energy savings .....	11
4. Wind energy.....	15
5. Wave energy .....	21
6. Geothermal energy.....	25
7. Bioenergy from biomass .....	31
7.1. Biogas plants.....	33
7.2 Biomass-powered heating and power plants.....	37
7.3 Biofuel systems.....	41
8. Solar Energy.....	47
8.1 Solar Energy – SHW systems .....	49
8.2 Solar Energy – PV systems.....	53
9. Hydro Power .....	57
10. Fuel cells .....	61
11. Comparison of scopes of application.....	65
12. Comparison of price levels .....	67
13. Consumption of sustainable energy in Europe .....	69
14. Energy authorities in Europe.....	71
15. Energy unit conversion table.....	77
16. References and links .....	79





# 1. Introduction

## **Contents of the catalogue**

This catalogue offers planners and decision-makers in the EU member states a tool that can be used during the first stage of a local or regional transition to sustainable energy technologies – long term solutions that, in principle, could last forever.

The catalogue can also be used by anyone who needs an overview of energy technologies, their current development level and future potential.

The catalogue provides – to a considerable extent – the same detailed information for each of the different technologies, which makes it possible to weigh the pros and cons. Thus, the catalogue provides suggestions for the developmental direction of future energy supplies in the EU, based on renewable energy.

The catalogue offers information which cannot easily be researched on the Internet: an overview of each individual technology with regard to stage of development, best available technology, supply potential, environmental impact, etc.; a comparison between the different technologies and information on how the technologies can interact with each other and with the energy system.

The catalogue is designed to facilitate the first deliberations of local or regional authorities wishing to support initiatives for the development and extension of renewable energy. Not all energy source or energy technologies are presented in this catalogue, but a wide selection has been chosen.

Therefore the catalogue encourages readers to gather the necessary knowledge for making the final decision to start projects. At the back of the catalogue under “References and Links”, there is a list of contacts, pamphlets, web pages, etc., where it is possible to find more information about the individual technologies.

## **Why focus on sustainable energy?**

There are many good reasons for considering increased use of sustainable energy sources and technologies that can supplement, or in the long run – in combination with increased energy efficiency – perhaps even replace, the conventional energy production types that are most prevalent in the EU today. One reason could be consideration of the future security of supply. How long can we be sure of deliveries of coal, oil and natural gas at affordable prices?

Environmental considerations are another reason to choose alternatives to the conventional production types. The burning of fossil fuels contributes to global warming, acid rain and pollution of our air, drinking water and foods. Therefore, we should consider how long we are able count on the good will of international society towards our high consumption of fossil fuels for energy purposes.

A third reason to aim at renewable energy technologies is the employment and export possibilities that exist in connection with research and development in the field. EU member states have many research environments within many different technologies for transformation of renewable energy – some more developed than others. A common trait for many of these is that the researchers involved see possibilities for using the technologies in a commercial context – but these possibilities do not really become relevant until the technologies are given the necessary financial push in the right direction.

## **How to read the catalogue**

The catalogue provides a short introduction to a number of technologies that are already, or are estimated to become, central to development in the field of renewable energy in the EU.

Naturally, some of the important steps on the road towards more renewable energy are continued development and implementation of technologies for transformation of renewable energy.

Therefore, the catalogue contains an overview of a number of different technologies for transformation of renewable energy, such as solar heating systems, wind turbines and biogas plants. However, other and just as important steps are development and implementation of technologies that can support new infrastructures in the energy system, and technologies that can promote flexibility and savings on the consumption side. Therefore, the catalogue also includes a section about the energy system – and, included in this section, a part about technologies for efficient use of energy. Furthermore, it concludes with a part about fuels cells.

The catalogue does not contain a common timeframe within which all the technologies are expected to have come into use. Instead, a timeline that spreads towards (further) commercialisation is outlined for each technology. This timeline includes significant events with regard to research and development, the market and policies that are expected to be of importance to the success of the technology. The timeline can be 10 years for one technology and 30 for another, as the basis for assessment of future prospects is different from technology to technology. In this way, promising technologies are not excluded solely on the basis of a long timeframe.

There are many uncertainties connected with the assessment of technologies that are still far from fully developed. Therefore, the catalogue mainly focuses on describing the status of each technology at the time of this catalogue's publication (end of 2006). Qualified (but subjective) estimates are given of the future potential of the energy technologies in the EU through expert assessments. The subjective estimates of the future potential of each technology are also expressed in the timeline for each technology.

### **Calculation of prices**

As regards calculations of production prices for each technology, it should be emphasised that there are many uncertainties. Especially in cases where there has not yet been any experience with commercial systems, and where the price level has been calculated solely on the basis of experiences with test or demonstration systems. For this reason, we have chosen to indicate a *price level* for each technology, calculated on the basis of a typical system for the technology in question. That is to say, the production prices are not precise, which would also be beyond the scope of this catalogue. Thus, the indication of price level should be seen as an estimate of the price level of the individual technologies, and cannot be used as a basis for budgeting and the like. The back of the catalogue contains an overview of the price levels of all the technologies. To make comparisons possible, all indications of price level in this catalogue are stated in Euro/kWh. In connection with energy units of measurement, there is a conversion table at the back of the catalogue.

### **The structure of the catalogue**

In the catalogue, we distinguish between energy sources, i.e. sources that renewable energy comes from (such as the wind), and energy technologies, i.e. technologies that are used to transform the renewable energy (such as wind turbines).

The overall structure of the catalogue is based on the energy sources that the catalogue deals with, which means that the catalogue contains six chapters about energy sources; wind energy, wave energy, geothermal energy, bioenergy from biomass, solar energy and hydro power. Each chapter contains sections about the technologies to which the energy source in question delivers energy. For example, the section about solar heating is to be found in the chapter about solar energy, and the section about biogas in the chapter about bioenergy. Before the six chapters about technologies for transformation of renewable energy comes a chapter about the energy system – and included here are parts on technologies for the efficient use of energy and fuel cells as energy carriers.

One of the major challenges for the development of a sustainable energy solution is to find a sustainable alternative energy carrier suitable for the transport sector, at present almost 100% based on oil products. Hydrogen is investigated as an alternative energy carrier, in specific for the transport sector. However, the potential for hydrogen as an energy carrier (in the form of H<sub>2</sub>) is still very uncertain and (more) attractive alternative sustainable energy carriers for the transport sector may result in, that hydrogen will never become economic and technical attractive as a significant energy carrier.

Why have we chosen these particular energy technologies rather than other technologies such as, for example, gas turbines and gasification? The main conditions for being included in the catalogue are that the technology is sustainable and up-and-coming, with an expected large potential. We could have included a few other technologies such as, for example, heating pumps, but we had to prioritize due to the size of the catalogue.

The text on each technology and the catalogue as a whole is reviewed and evaluated by external experts, ETAG members executing peer review, STOA panel officials and STOA panel members. The process of reviewing the catalogues has been ongoing through all stages of the working process. ETAG members and STOA panel officials have reviewed the draft plan and interim report. The text on each technology in the final report has been reviewed and evaluated by external experts and a summary of each review is placed in connection with the individual technology. The final catalogue, including the summary of the experts' evaluation, is reviewed by ETAG members and STOA panel officials. Finally the catalogue has been presented to the STOA panel members and their comments are included in the final version of the energy catalogue.

### **Key concepts of the text material**

**Introduction to the technology:** Gives the reader a general overview of the technology including the use of the technology.

**Best available technology:** Examples of some of the newest and most promising projects/systems within each technology, and information about the newest initiatives within research and development of the technology.

**Supply potential:** An assessment of potential use of the technology. The assessment includes whether any areas/types of buildings, etc. have more potential than others.

**Environmental impact:** Environmental advantages or negative environmental effects of using this energy technology. The energy balance of the system, i.e. the relationship between the energy that the system produces during its life span and the energy used to establish, run and dismantle the system, is also mentioned, where it is relevant. For some energy technologies, the term "energy payback time" is used, i.e. the time it takes for the system to produce the amount of energy it takes to establish, run and dismantle a system.

**Economy:** An assessment of how the technology does financially. Please note that prices depend on many variables concerning the area specific accessibility of an energy source and placement the energy facilities. Therefore the prices mentioned are examples.

**Interaction with the energy system:** which other energy technologies support and/or can be supported by the energy technology – and how can the technology interact with the energy system.

**Advantages and disadvantages:** Outline of the most important advantages and disadvantages of the energy technology in question.

**Geographical parameters:** An assessment of where the energy source is situated and where it can be used.

Please note that, with regard to some of the technologies, a few other key concepts besides the above-mentioned are mentioned.

## 2. Energy systems

### Introduction to energy systems and energy services

The energy system covers the entire complex of interrelated elements, actors and markets that deliver energy services to different sectors of society. What the society is looking for is not energy as such but all the different related services. The final energy services include, for example, the production of food, providing the necessary transport facilities and maintaining room temperature in buildings. The energy flow is from source-to-service, but a sustainable strategy has to consider other options. It is therefore recommended to start with the desired energy services and then identify solutions and energy chains, which meet object function requirements in the most sustainable way. The two prerequisites for sustainable energy system development are:

- to increase energy efficiency from “service-to-source”.
- to extend the use of renewable energy sources.

Energy services are not necessarily stated in energy units (but, for example, in person-kilometres, in tons of food, in temperature or per m<sup>2</sup>). In general, societies are in need of increasing energy services, and this is very often linked to economic growth leading to increased energy demand – see below. The development of energy services is not normally a part of any energy policy.

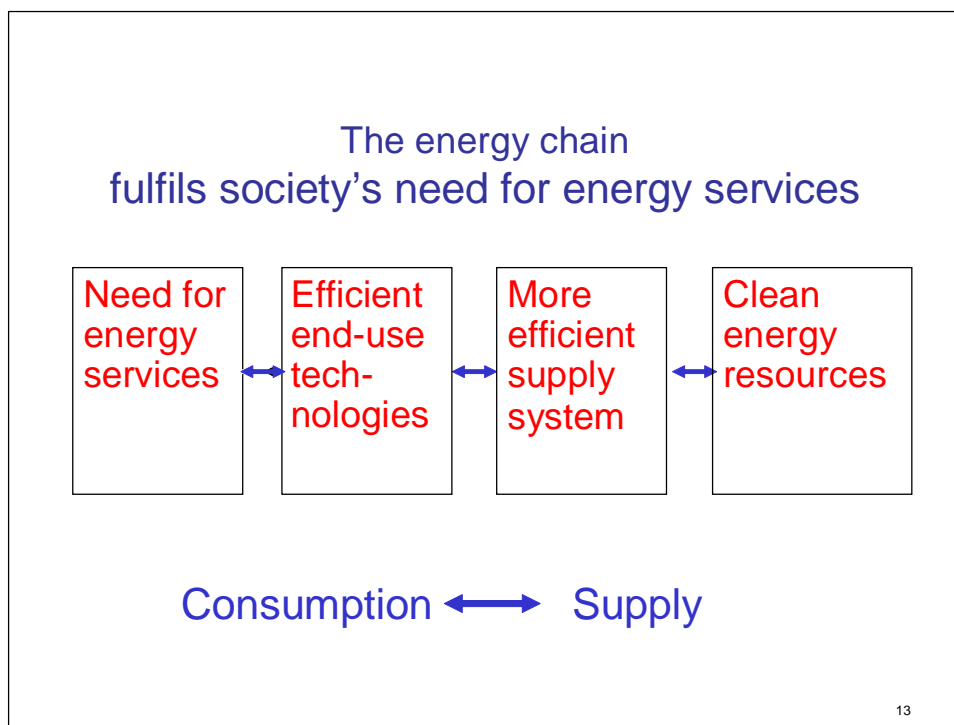

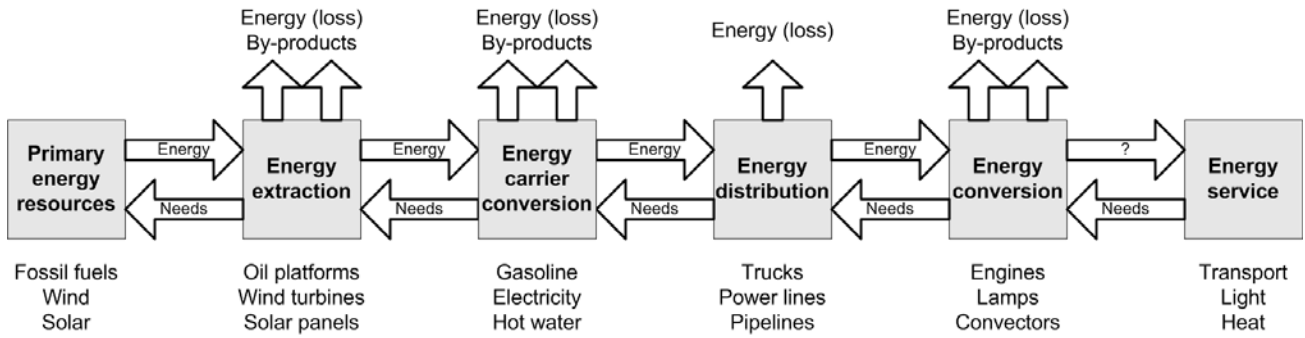

The above figure illustrates on the one hand the ‘requirement flow’ from society’s needs for energy services in terms of transport work, light and heating through the energy chain to the primary energy resources and on the other hand, the flow of energy from the energy sources through the various steps in the energy chain (energy extraction, conversions between energy carriers, energy distribution and final conversion) to the energy services.

### Energy efficiency

As part of increasing the energy efficiency for “service-to source”, it is important to look at all the possibilities and at the whole energy chain. There is in general a huge potential for reducing end-use consumption by, for example, constructing more energy efficient buildings, appliances and cars.

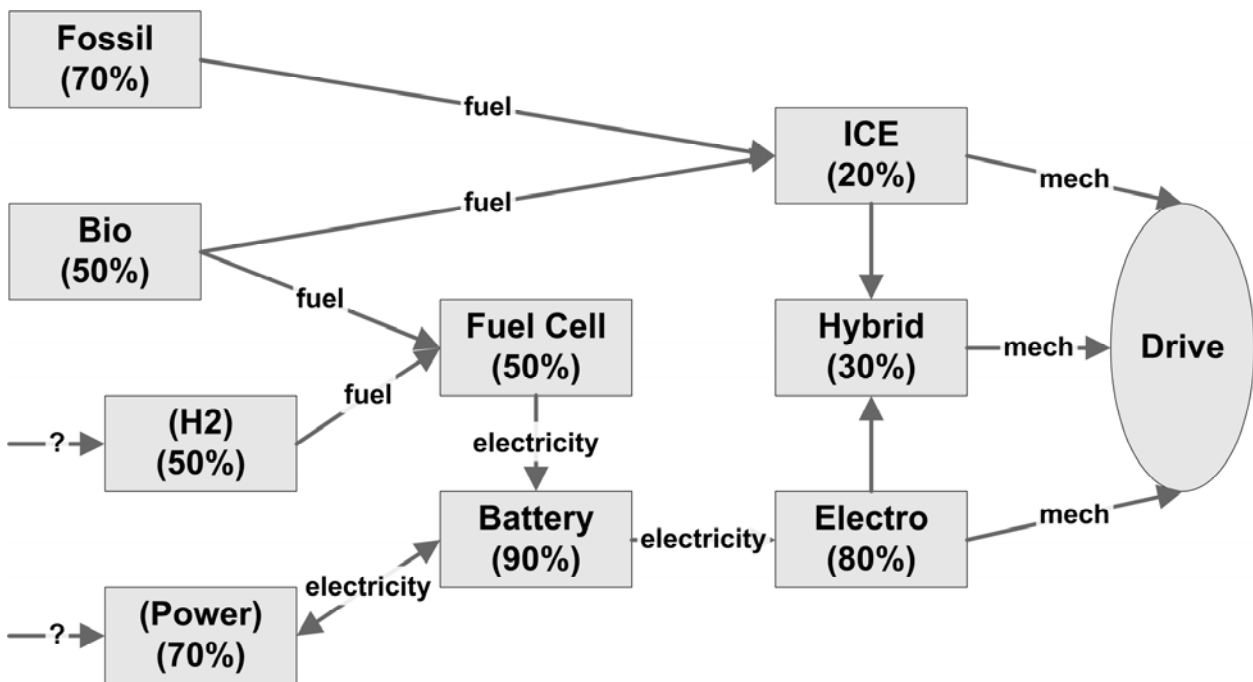

The above figure illustrates typical energy efficiencies (in %) at the various steps in different energy chains from the energy sources to the final energy service, here the drive of a mobile application - from well to wheel. The total efficiency varies from 10% (Bio - IEC - Drive) to 50% (Power - Battery - Electro - Drive).

The most cost efficient ways to increase energy efficiency are often based on finding new solutions through proper planning and design – like local production and processing of natural food

resources, reducing the need for transport work through proper town planning, and energy conservation for maintaining room temperature through proper building design.

It is also important to increase the efficiency of the whole supply system. This means more efficient boilers, power plants, etc. Combined heat and power production is one important way to increase the efficiency of the supply system.

Extended and efficient use of renewable energy sources – in specific intermittent sources like solar and wind energy – requires:

- flexibility in the energy system (in order to absorb fluctuating, unpredictable production services).
- links between the energy sector and other sectors.

### **Integrated energy systems**

An energy system consists of a complex combination of energy technologies, energy carriers and energy resources, performing together the various energy services required. No single energy service, energy technology, energy carrier or energy resource can be evaluated isolated from its context in the entire energy system. Any change within the energy system will have an influence on the remaining part of the energy system – as clearly illustrated, for example, by the changing conditions for renewable technologies caused by change in world market oil prices.

In principle, energy never disappears, but energy in different forms has different values (e.g. 1 energy unit of fuel is more valuable than 1 energy unit of heat), and energy can be set free (e.g. as heat) if it is not utilised. The entire energy system should be designed to optimise defined objectives and targets (the object function) by maximising the value of energy and minimising the amount of unused energy (energy ‘losses’). This may be obtained either by increasing direct energy efficiency or by utilising the remaining energy for other purposes. Increased energy efficiency from source-to-service requires high efficiency in all steps of the energy chain from the energy resource to the final energy service.

In order to achieve a high security of supply and strong resistance to unforeseen economic, political or technological changes, an appropriate set of complementing and supplementing energy chains should be identified, based on diverse technologies, energy carriers and primary energy resources. Overall efficiency should be optimised by the use of combined conversion technologies, linking the energy sector and other sectors like the agriculture sector and the transport sector. Examples of this are combined heat and power generation or the more complex bio-refineries producing a combination of biofuels for mobile applications, electricity, heat, animal feed and fertilizer from biomass.

### **Energy carriers and storage**

The distribution of energy from energy sources, via converters to the final services is made through the energy carriers – like coal, oil, gas, biomass, electricity, heat, etc. – and the infrastructure – such as trucks, pipelines, power lines, etc. Most energy carriers are synthetically produced – like petrol and diesel from crude oil in chemical refineries. The various energy carriers have different characteristics, which are suitable for different applications. The energy carriers are also used to

store energy. Electricity, natural gas and biomass are the three most important for stationary applications – in households, CHP and industry.

The energy densities in weight and volume and the loading time are important parameters for mobile applications and alternatives to the fossil fuel based petrol and diesel fuel.

The present energy carriers – inclusive those based on fossil fuels – will not disappear overnight. But time and investment are needed to develop new technologies and to establish the supporting infrastructure. Electricity, biofuels and perhaps hydrogen are expected to become the most important energy carriers in the long term. Some of the promising alternative energy carriers in question are:

- Hydrogen ( $H_2$ ): is easy to produce (e.g. from electricity by electrolysis), is  $CO_2$ -free at end use, but is (still) difficult to store at high energy density.
- Ammonia ( $NH_3$ ): is easier to store at high energy density, is also  $CO_2$ -free at end use, but the energy chain from production to final use is (still) not very energy efficient.
- Methane ( $CH_4$ ): can easily be produced from all kind of biomass (e.g. by gasification), and may be fed directly into the natural gas pipelines, as the main part of natural gas is methane.
- Ethanol ( $C_2H_5OH$ ): Can directly substitute (part) of the petrol for use in ignition combustion engines. Can easily be produced (e.g. by fermentation) from that part of the biomass that is otherwise used for food production (e.g. corn, sugarcane). Production processes based on wood, straw, etc., are still not very energy efficient.
- DME ( $CH_3OCH_3$ ): is easy to produce from fossil fuels (e.g. coal or natural gas), has a high energy density and can be used in diesel engines with reduced pollution in the exhaust.

On average, over time, the energy production of each energy carrier matches exactly consumption plus losses. But, as both production and consumption fluctuate on different time scales and not necessarily in phase, storage is needed for each of the energy carriers. Oil is to a high degree stored in fleets of oil vessels, natural gas in underground caverns, petrol in tanks, heat as hot water in district heating systems, etc.

Huge amounts of electricity are (still) difficult and expensive to store, and with the increasing fluctuating production from, for example, wind power, power supply systems will need an increased flexibility in order to balance production and consumption at any point at any time. Conversion between power and another energy carrier is one of the means possible. Electricity can easily and energy efficiently be converted by electrolysis to hydrogen, and hydrogen can with high energy efficiency be converted by fuel cells to heat and electricity. The main problem is the storage and distribution of the hydrogen. On the other hand, the development of new battery types with interesting and promising characteristics may form the basis for electrical vehicles that moreover can contribute to flexibility in the power supply system when connected for charging. This solution provides a direct link from, for example, wind power to the transport sector.



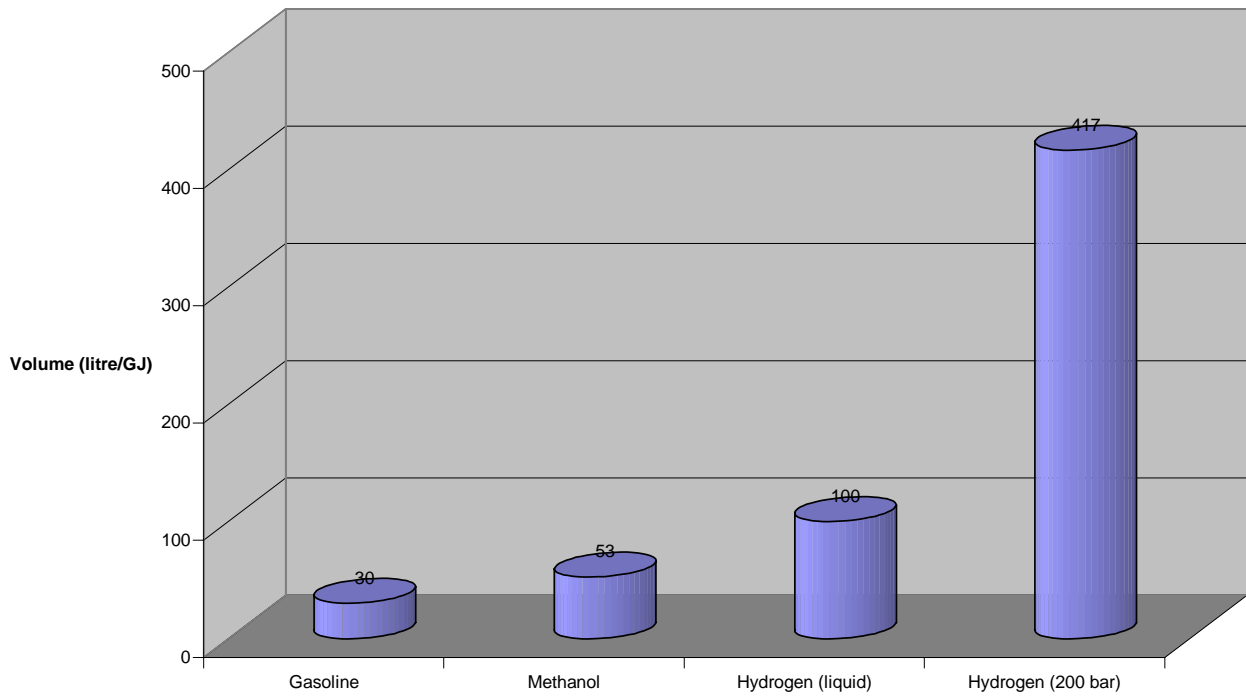

Figure text: The illustration compares the volume (in litres) needed by different energy carriers for holding the same amount of energy (1 GJ).



### 3. Efficient use of energy – energy savings

#### **Introduction to efficient use of energy**

Increasing the end-use energy efficiency in all sectors and end-uses is an important element in a sustainable energy strategy, as mentioned in chapter 2. We have to reduce energy consumption by improving energy efficiency as part of a strategy where renewable energy sources cover a big share of the total energy consumption.

Higher end-use energy efficiency is a key element in meeting international and national environmental requirements. The huge global need to reduce emissions of CO<sub>2</sub> from the use of energy, with particular regard to the stabilisation of greenhouse gas concentrations, requires a significant increase in energy efficiency, in energy production and end-uses, as well as increasing the use of renewable energy sources.

Improving end-use energy efficiency is also, in the long term, a significant way of reducing dependency on fossil fuels and reducing vulnerability to increases in the price of energy. This will help to increase long-term energy supply security. In the short term, energy efficiency, combined with a more flexible consumption, can help to reduce the need for investment in new electricity production capacity in the transmission network, and thus increase energy supply security.

Implementation of cost-effective energy savings will reduce the consumer's energy bill and give benefits to society. As such, it is a part of improving welfare, competition and growth.

Overall, reducing energy consumption by energy efficiency improvements will help to meet the challenges that we are facing in the light of globalisation and growth, security of supply and global environmental problems.

There is a significant potential for energy efficiency and energy conservation. The technical energy-saving potential of household appliances, computers, ventilation systems, windows, etc., has been estimated at 30-50% compared to the consumption today.

A big part of this potential is economically attractive. The EU Commission states<sup>1</sup> that the cost-effective saving potential is at least 20% of the actual consumption. The Danish action for a renewed energy-conservation<sup>2</sup> effort shows a 24% socio-economic potential until 2015, and a 42% potential, which is economically attractive to consumers. The reason for this difference is the taxation of energy.

On the whole, within the EU, more than 40% of the energy is used in buildings, and studies show that a very big part of the saving potential is also related to buildings. But there are cost-effective savings in all sectors and end-uses.

Compared with most supply options, the economic potential of energy efficiency is in general very favourable. The more efficient technologies and solutions are maybe more expensive, but this extra cost is normally paid back after a few years by the energy savings.

#### **Policies and measures**

For various reasons, a number of profitable energy savings are not currently being realised. This is partly due to various forms of barriers, dysfunctional incentive structures and inexpedient markets for energy-efficient products and solutions. Such barriers include lack of information and knowledge, disadvantageous financing conditions, etc.

---

<sup>1</sup> "Doing more with less, Green Paper on Energy Efficiency", COM(2005) 265 final of 22 June 2005. [http://ec.europa.eu/energy/efficiency/doc/2005\\_06\\_green\\_paper\\_book\\_en.pdf](http://ec.europa.eu/energy/efficiency/doc/2005_06_green_paper_book_en.pdf)

<sup>2</sup> "Action Plan for a renewed energy-conservation", Danish Ministry of Transport and Energy, 2005

There is a need for policies and measures to overcome these barriers. The measures shall focus on a cost-effective realisation of the large, profitable energy saving potential. It is therefore important that the costs related to the measures are as low as possible.

Implementation of energy savings should in general be seen as a transformation of the markets for the different energy-using products and systems. The markets should be compelled to deliver more efficient products and dynamical measures should be taken to promote innovation. To this effect, a savings strategy should include:

- *less* use of products with low energy efficiency. Measures to secure this could be minimum efficiency standards, building codes, etc.
- *more* use of products with high energy efficiency (BAT – Best available Technology). Measures to promote this could be energy labelling, economic incentives, information and campaigns.
- *new* products – development of the next generation of energy efficient products. This requires research, development and demonstration.

As part of such a strategy, energy saving activities should not only focus on the consumer, but also on the manufacture of the products and systems and on retailers, construction companies, etc. Many of the savings are related to buying new products and systems, and it is therefore very important to give the right incentives and information in a buying situation.

### **New buildings**

Buildings have in general a very long lifetime and it is therefore important to ensure that new buildings use as little energy as possible. Upgrading a building to higher energy efficiency later on is much more expensive than doing it at the time of construction.

The technology is already available for construction of new buildings with very low energy consumption (passive houses). In the past few years, many passive houses have been built, especially in Germany and Austria.

Mandatory energy requirements in buildings codes are the best instrument to secure that all new buildings are energy efficient. As part of the EU energy performance of buildings directive<sup>3</sup>, all member states should update their building codes every five years, and the energy performance criteria should focus on reductions in the use of delivered energy. The calculation of performance should include energy used for heating, hot water, ventilation and cooling, permanent lighting, boilers, etc. Among other things, this applies to the development of a totality-oriented building design that combines energy efficiency with optimal use of solar energy.

As a supplement to the minimum requirements in building codes, it is important to give incentives to establish buildings with low energy consumption (passive houses, etc.). Certification of new buildings is one way of doing this, but it is also important to encourage local activities (campaigns) and economic incentives. Public authorities should have a specific obligation to establish low-energy buildings.

### **Existing buildings**

There is a huge saving potential in existing buildings through implementation of technologies and solutions, which are already available at the market. The best and cheapest way to implement these savings is to do it as a part of renovation and installation of new equipment and components.

---

<sup>3</sup> Directive 2002/91/EC of the European Parliament and of the Council of 16 December 2002 on the energy performance of buildings (EPBD)

Therefore, one of the elements included in the EU energy performance of buildings directive<sup>4</sup> is that it is mandatory to implement cost-effective savings as part of major renovations of buildings over 1000 m<sup>2</sup>. These obligations can be supplemented by minimum efficiency requirements for buildings components (boilers, windows, insulation of new roofs, etc.) when they are replaced. All member states shall, as part of the implementation of the building directive, also implement systems for the energy certification of buildings, when they are sold. The certification shall provide information on the building's energy performance and suggestions to reduce energy consumption. The certification will not in itself secure the implementation of savings but can provide a very good basis for other national and/or local activities.

### **Appliances and products**

There is a huge potential for reduction of the energy (normally electricity) consumption in appliances and products. If the whole stock of appliances in households was changed to the most efficient technology, the consumption of electricity could be reduced by up to 50%. Significant savings can therefore be achieved if energy-efficiency is emphasised when purchasing new and exchanging existing products.

With regard to appliances, the most important element in an active energy-saving effort is ensuring that new appliances are energy-efficient. It is normally impossible to improve the efficiency of an existing product. Policies ensuring that new appliances are energy efficient are a combination of minimum efficient requirements, energy labelling and local information campaigns.

The mandatory EU energy labelling scheme (A-G)<sup>5</sup> is a good basis for energy-efficient purchases, and it can be used both in local campaigns and as the basis for subsidy schemes, but the label targets have to be updated. In the coming years, the Commission will implement minimum efficiency requirements based on the Eco-design directive.<sup>6</sup>

### **Geographical parameters**

Obligations and targets regarding the energy efficiency of buildings have to be seen in relation to the huge variation in climate between the different member states and regions in the EU. In the north, the focus is on reduction of heat consumption and in the south, cooling and air-conditioning is very important. But in all cases, improvement in energy performance (better insulation, better windows, efficient boilers, etc.) is very important.

With regard to appliances, there is very little geographical variation.

### **Timeline**

- 2006: all member states should implement the EU's building directive (EPBD). In this connection, member states have to consider tightening the minimum requirements in building codes.
- 2006: the EU Commission will present a new action plan on energy efficiency.

---

<sup>4</sup> Council Directive 92/75/EEC of 22 September 1992 on the indication by labelling and standard product information of the consumption of energy and other resources by household appliances.

<sup>5</sup> Council Directive 92/75/EEC of 22 September 1992 on the indication by labelling and standard product information of the consumption of energy and other resources by household appliances

<sup>6</sup> Directive 2005/32/EC of the European Parliament and of the Council of 6 July 2005 establishing a framework for the setting of ecodesign requirements for energy-using products and amending Council Directive 92/42/EEC and Directives 96/57/EC and 2000/55/EC of the European Parliament and of the Council

- 2007: as part of the implementation of the directive on end-use energy efficiency and energy services<sup>7</sup>, all member states shall deliver an Energy Efficiency Action Plan to the Commission.
- 2006-2010: growing prevalence of sustainable building with intelligent houses, where the indoor climate is controlled according to the influences of, for example, the sun and the wind.
- 2008: update of energy labelling targets for cold appliances and for washing machines and dishwashers
- 2009: minimum efficiency requirements come in to force for several products.
- 2010: possibility for further tightening of the energy requirements for new buildings, as the EU building directive states that the energy rules have to be revised every five years.
- 2010: mandatory efficiency targets for new cars and trucks.
- 2010: the member states have to deliver the next energy efficient action plan.
- 2010: the start of energy savings in connection with shipping and air traffic is expected.
- 2015: mandatory energy requirements for new buildings and for renovation of existing buildings.
- 2020: all new buildings are low-energy buildings (passive houses).
- 2030: a big part of the existing building stock has been renovated to low-energy buildings.

### External expert comments

#### Satu Helynen

Investments and actions regarding the efficient use of energy and energy savings can in many cases be more economic for the whole society than building new plants for heat and power generation. Efficient use of energy and energy savings has to be simple and clear enough for consumers and those who are not experts, – dissemination of reliable information on the possibilities for reducing energy consumption is crucial. In this sense, labelling of products according to energy efficiency has given really good results. New technology used for reporting on-line energy consumption at home – and also for the automatic control of heating and cooling and for optimising the time of electricity use - can be a reality in the near future.

Voluntary energy conservation agreements play an important role in the Finnish energy conservation program, as part of the national climate strategy. The objective of the energy conservation agreements is to achieve lower specific energy consumption levels, and to integrate energy efficiency issues into the daily proceedings of both companies and communities. The agreements cover 60% of the Finnish total energy use. The voluntary agreement scheme has been launched for industrial companies, the energy sector, the district heating sector, the electricity transmission and distribution sector, the construction and real estate sector, the transport sector and for the municipal sector. The parties to the agreement are committed to starting up energy audit or analysis operations and to compiling a plan on saving the energy they consume. The government is committed to supporting energy audits or analysis operations and energy-saving investments fulfilling set criteria, financially.

<sup>7</sup> Directive 2006/32/EC of the European Parliament and of the Council of 5 April 2006 on energy end-use efficiency and energy services and repealing Council Directive 93/76/EEC

## 4. Wind energy

### Introduction to wind energy

Wind energy research and development followed by deployment of wind power have been important European issues since the energy crisis in 1973. The development of wind energy has been favoured by individual countries, as well as through initiatives at the level of the EU and international organizations. The development of renewable sources will contribute to the security of energy supply, reduce fuel imports and dependency, reduce green house gas emissions, improve environmental protection, uncouple economic growth from resource use, create jobs and consolidate efforts towards a knowledge based society.<sup>8</sup>

EU member states have supported the development of wind energy by implementing specific policies promoting the use of energy from wind and other renewable sources. These policies include the setting up and running of R&D programmes and a number of measures to improve the deployment of wind energy, in particular supporting its use for power production. Wind power is believed to have a large potential for making an important contribution to the fulfilment of European energy and climate strategies.

During recent years, research and integration efforts have been concentrated on solving challenges of onshore as well as offshore wind energy installations. Scientific topics in focus have been innovative new materials, enhanced aerodynamics, control and regulation strategy and system development, operation and maintenance monitoring strategy and system development, as well as novel designs for wind turbine structures and foundations. Additional methods and techniques that reduce the uncertainty of costs and production levels have also been developed. In a large European project<sup>9</sup>, the aim is to investigate the challenging question of how large a wind turbine it is possible to construct based on available present day technology and to advise about new construction technologies.

Member states' targets have been set for the deployment of renewable sources, including wind energy, to supply power and heat into national energy systems. Market introductions have been favoured by the implementation of supporting schemes. When external costs are not taken into account, market introduction strategies and active support are needed for renewable energy during a limited period of time. Agreements with power companies were made in some countries both on agreed favourable feed-in tariffs for the electricity produced, and also on the obligation of the power companies to install a number of MWs in large projects in order to demonstrate the economical feasibility for making use of wind turbine technology in a power system.

This situation places a specific challenge on European power companies to prepare their grids to accept a large amount of wind power in the electrical network. It is necessary to maintain the stability of the grid when the distributed generation from wind energy and other decentralized sources becomes a high fraction of the total power. Research and demonstration has been addressing the design and management of electricity grids linked to large-scale wind power generation.

Wind resource estimates and measurements are very important in order to secure electrical stability and to assess the need for back-up on a timescale long enough for starting up supplementary power generating units or adjusting the electricity needs.

---

<sup>8</sup> As stated in COM(2004) 366.

<sup>9</sup> UPWIND, Framework Programme VI.

## **Technology information**

A wind turbine can utilise the wind, when the wind force is between 2 m/s and 28 m/s. The maximum electricity production is achieved at a wind force above about 13 m/s. The development is moving toward fewer turbines with larger and larger capacity. Globally, the average size of wind turbines installed rose from 2004 to 2005 from about 1250 kW to a value somewhat larger than 1350 kW. For offshore purposes, only the largest turbines are being used, sizes from 2 MW and upwards. With current technology, it is expected to be possible to construct an offshore wind turbine with a capacity of 5-10 MW. Yet, the current technological level of wind power can be compared with the development stage of the car industry in 1950. There has been a huge development, but there are still large unused potentials just waiting to be uncovered and used commercially – such as the development of more cost-effective and intelligent turbines with higher efficiency and a more optimal design that reduces the consumption of materials and maintenance costs.

## **Best available technology**

New large turbines are usually three-bladed and connected to an electrical system. German projects include pilot projects with turbines of sizes between 5 and 8 MW; these are a 5 MW Repower turbine with rotor diameter of 125 metres and a turbine from Enercon with rotor diameter of 120 metres and designed for different generators rated 5, 6 or 8 MW depending on the actual wind conditions on the site where the turbine will be positioned.

One of the newest and most modern land-based turbines with a rotor diameter of 112 meter is situated at the Danish test station of Risø National Laboratory at Lemvig (Høvsøre); this is a Vestas (Micon) turbine with a capacity of 4.2 MW.

In some member states, many turbines will in future be placed at sea, where they will be less inconvenient to people than they are on land. At the same time, many countries are discovering that the really large energy potential of wind power is at sea. Several trial demonstrations with offshore wind farms are in progress in the UK, Germany, Denmark and the Netherlands.<sup>10</sup>

## **Supply potential**

Wind power has a very large supply potential. The expansion possibilities on land are great with regard to replacing smaller wind turbines with larger and more efficient ones. Studies have shown that it is possible to adapt and control the Danish power supply in order for approximately half of it to come from wind power. Here, the largest challenges are to handle the effect and energy balance – that is to say the balance between production and consumption during operation – in an electrical power network with as high a share of wind energy as possible.

## **Environmental impact**

Production of wind power is free of emissions or waste products, but has some environmental impact from the turbine construction and scrapping stages. However, a large part of the materials can be recycled. Installing offshore wind turbines will cause some disturbance to the sea environment. However, the few existing studies of the environmental impact of offshore wind farms show only a limited negative effect on the animal and bird life at sea. Further investigations are taking place and will be carried out in the future.

## **Technology lifetime**

---

<sup>10</sup> for example, at Horns Rev in the North Sea, 16 km west of Denmark, where 80 turbines have a total capacity of 160 MW.



Wind turbines are designed to have a technical lifetime of 20 years, and the energy balance of a wind turbine is highly positive. A Lifecycle Analysis for a wind turbine shows that with normal wind conditions it takes about three months to produce the energy used for manufacture, setting up, maintenance and scrapping of the turbine. Thus, a wind turbine produces approx. 80 times more energy that it uses during its lifetime.

### **Economy**

The cost of wind energy power generation has fallen steadily over the last decades – and a continued fall of 10-20 % is expected in the years to come, every time the wind turbine industry doubles the total capacity produced. Based on Danish figures, the current cost price (2005) for electricity produced with a land-based turbine is 0.033-0.040 €/kWh, and this price has been reduced by more than a factor of 2 since 1980. The kWh-price for the best sites on land corresponds to the price of electricity produced at a coal power station.

In Germany, for the initial 5 years of wind turbine operation, guaranteed prices for the electricity produced are 0.0836 €/kWh, thereafter decreasing to 0.0528 €/kWh for onshore turbines. For offshore projects, the corresponding figures are 9 initial years with 0.0910 €/kWh, thereafter decreasing to 0.0619 €/kWh. In Spain, an incentive of 0.03 €/kWh is obtained for projects up to a size of 50 MW in addition to the market price set year to year based on average pool prices, in 2005 adding up to a rate of 0.0627 €/kWh. In the UK, a quota system is being used for all electricity supplied by renewable sources, and the tariffs amount to a value between 0.0728 and 0.0777 €/kWh. Finally, in Denmark, the tariff is only 0.0361 €/kWh, including a CO<sub>2</sub> premium of 0,012 €..

### **Interaction with the energy system**

Seasonal interaction advantages between wind turbine and solar cells are expected. The reason for this is that wind turbine produces considerably more electricity during the six-monthly winter period than during the summer, while it is the other way around with solar cells. Today, the greatest challenge in the wind energy area is to integrate wind power into the total power supply system.

### **Geographical parameters**

Wind energy resources in all European countries have been mapped in a European Wind Atlas. In the Atlas is shown the wind energy potential, which is to be used when calculating the power production per unit size of wind turbine capacity installed. It shows great variations across each country as well as from one European country to the next. As a follow-up to the Atlas, the computer program, WASP – Wind Atlas Analysis and Application Program - was created to calculate the expected power production using a specific turbine at a specific position.<sup>11</sup> These tools are very important when planning offshore and onshore siting of wind turbines, implementing wind energy in an energy system or developing turbines best suited to capturing the available energy at any individual position.

By the end of 2005, about 41 GW of wind power was installed in Europe or 69% of the total capacity installed in the world (59.3 GW). World market growth rates have been very high since year 2000, more than 20% per year, and consequently the capacity has more than tripled during this half decade. The European market has been a prime driver and 56% of all new installations in 2005 took place in Europe (mostly in EU15, about 54%). However, the largest single market in 2005 was the USA with 21.3%, while Germany and Spain followed with 15.8% and 15.5%, respectively.

---

<sup>11</sup> These tools have been developed at Risoe National Laboratory in Denmark with the support of the EU Commission.

### Wind turbine capacities in Europe, share of total installations and electricity production in 2005

Member State	Wind power installed	Share of European capacity	Share of national electricity
Germany	18.5 GW	31.1 %	6.7 %*
Spain	10.0 GW	16.9 %	7.79 %
Denmark	3.1 GW	5.2 %	18.50 %
Italy	1.7 GW	2.9 %	0.65 %
UK	1.4 GW	2.3 %	0.48 %*
Netherlands	1.2 GW	2.1 %	1.70 %*

\*: Figures are estimates

Within the member states, the amount of wind-generated electricity to meet the electrical demand varies from a barely detectable amount to 18.5 % in Denmark. Also Germany, Greece, the Netherlands, Portugal and Spain exceeded the 1 % mark for contribution of wind energy power to the member state's electricity demand.

In absolute terms, at present Germany and Spain are the main European markets for onshore turbines. In the future, an accelerated deployment of turbines offshore is expected in countries like Germany and the UK. Thus, by 2010, 2000 MW offshore wind power is expected to be installed in Germany. Also, offshore wind power is expected to play a strong role in the UK, where it is planned to integrate 7-8 % of renewable energy in the UK energy system by 2010. In Denmark, large offshore wind farms have already been in operation for some years, and new ones are in progress.

An important industrial development of the wind sector has taken place in many European countries. Thus, in 2004, the German wind energy industry had more than 45,000 employees. Today, the Danish wind turbine industry has more than 25,000 employees and a total turnover in 2005 of 4.4 billion Euros. The export share is well above 95 %, and altogether Danish companies have a world market share of about 35 %. This market is expected to be almost tripled in 2010 compared to 2005.

#### Advantages

- Wind energy does not result in emissions or waste products during production.
- Relatively low operating costs.
- After an operation period of 20 years or longer, a wind turbine can be removed, leaving no harmful traces.
- In general, wind conditions for offshore turbines are more favourable than the conditions on land. This means that the electricity production from offshore turbines during a year is 1.5-2 times larger than the production from similar turbines at most land-based positions.
- Wind turbines are expected to have a longer lifetime at sea because of less turbulent wind conditions compared to onshore locations.
- Local and regional development and employment potentials.

#### Disadvantages

- Relatively high initial investments.
- The electricity production from a wind turbine depends on the wind. Therefore, the turbines have to be supplemented by other energy sources and/or storage systems to adjust the production to the consumption at each instant.

- May have negative visual impact.
- Noise from wind turbines.

### **Timeline**

- 2005: Europe has installed wind turbines with a total effect of approx. 41 GW.
- 2010: Europe is expected to have wind turbines installed with a total power of approx. 88 GW.
- 2005-2020: continued optimisation of the turbines that dominate the market today of 750 kW-3 MW for integration into the grid system on land. Development of new large 5-10 MW turbines for large offshore wind farms.
- 2020: globally, a share of wind power in electricity production as high as 12 % may be reached. At the European level, this percentage is expected to be 20 %.<sup>12</sup>
- 2030: the growth in wind energy's share of the energy supply will be increased if the necessary storage media are developed.

### **External expert comments**

#### **Satu Helynen**

Wind power is a good example of the rapid learning process in developing and implementing new energy technology. Average size has increased significantly and at the same time, specific investment costs have decreased dramatically. National incentives have shortened the time needed for wide implementation of the technology.

Wind energy is a typical example of a renewable energy source, the utilisation of which requires a good knowledge of local conditions. The economy of turbines can vary considerably based on their positioning. Another geographical parameter is connected to the icing of blades, something that needs special technical solutions in arctic conditions, such as in Finland.

Wind turbines represent a renewable energy technology that can generate electricity with very low demands of operation and maintenance staff. After the investment phase, variable energy production costs are very low and remote operation is possible also in very isolated geographical areas.

---

<sup>12</sup> In Denmark, it is expected that wind turbines will be installed with a total capacity of 5,500 MW or more – corresponding to around 50% of the electricity consumption.



## 5. Wave energy

### Introduction to wave energy

There is no leading or commercially viable wave power technology available at the present time (2006). However, several different systems are being developed, a few being prototype tested at sea and others developed on a more fundamental level, including tank testing and design studies. Demonstration of full-scale prototypes is necessary in order to validate the predicted technical performance, the costs of generation, the reliability and survivability of the concepts. This requires massive investments and only successful results will ensure that research and development progresses.

Over the last 25-30 years, progress has been slow, results have been scarce and support for development has fluctuated in different countries.

Wave energy as a source of power was recognised as early as the end of the 1700s, but not until the first energy crises in the 1970s was it subject to any research and development.

Following the energy crises in the period 1974-1985, wave energy R&D programmes were initiated in different European countries as well as under the IEA, involving Japan and the USA testing an offshore wave power plant with the name “Kaimai”. The first large wave energy development programme was initiated in the UK, followed by programmes in Norway and Sweden. The Swedish programme resulted in the pilot testing of two float based systems – the IPS system and the Hose-pump system. The Norwegian programme resulted in the establishment of two on-shore wave power plants, the overtopping principle Tapchan and the Kvearner Oscillating Water Column (OWC) principle. The UK programme resulted in the building of a small OWC project on the island of Islay.

During the period 1986-1996, the Danish Wave Power pilot project was tested in the North Sea. These projects demonstrated through continuous long sea tests that it was possible to generate power from the waves, but also that it was unlikely to be economical without further long term dedicated R&D effort.

In 1991, the European Commission initiated the Preliminary Actions in Wave Energy under Joule II.<sup>13</sup> It was a 3-year study with four components: Resource Evaluation, Generic Study on Wave Energy Converters, European Pilot plant study and European Wave Energy Network. Following the initial activities came the building of the OWC pilot plant on the Azores and a joint research action involving 20 EU partners in The Offshore Wave Energy Converter Project OWEC-1 during 1994-95. In 1997, the Danish Parliament decided to finance a wave power programme, which continued until the spring of 2002. The programme made it possible to examine and test approximately 40 different wave power concepts on a small scale in wave tanks. One of these systems, the Wave Dragon, was able to secure funding beyond the duration of the wave energy program in order to build a sea test scale model in 2003. The scale model placed in Nissum Bredning has, during the test period 2003-2006, delivered power to the electrical grid. In Japan, the building and installation of the floating OWC “Mighty Whale” was tested at sea during 1998-2002.<sup>14</sup>

In 2002, the UK showed renewed interest in the development of ocean energy and massive research is underway, pioneered by the Scottish team Ocean Power Delivery (OPD) development of the Pelamis 750kW system, tested in full scale in the Orkney Islands during 2005. OPD has now about 40 employees and financial support from private investors as well as the UK government.

---

<sup>13</sup> Wave Energy Converters, Generic Technical Evaluation Study, DG XII Joule Wave Energy Initiative Preliminary Actions in Wave Energy R&D, August 1993.

<sup>14</sup> Research and Development of Technology on Wave Energy Utilization, Development on Offshore Floating Type Wave Power Device “Mighty Whale” Jamstec 2004.

In 2001, the Implementing Agreement on Ocean Energy under the International Energy Agency was signed by three member states, the UK, Denmark and Portugal, followed by Ireland and Japan in 2002, Canada and the European Commission in 2003, USA in 2005 and Belgium in 2006. In 2004, the European Commission supported the Coordinated Action on Ocean Energy; this is a three-year programme involving 41 partners within the EU. Every half-year, the partners meet at workshops to discuss and exchange information in order to facilitate accelerated development. In 2006, Ireland announced the establishment of a development programme for wave energy and a 1:4 scale test site at Galloway Bay.

### **Technology information**

A wave power converter comprises a structure interacting with the incoming waves. The wave power is converted by a Power Take-off (PTO) system based on linear generators or hydraulic, mechanical or pneumatic principles driving a rotating electrical generator producing electricity. The structure is kept on a fixed mean position by a mooring system and the power transmitted to the seabed by a flexible submerged electrical cable and to shore by a sub-sea cable. Some are bottom-mounted, e.g. nearshore OWC.

If several devices are interconnected, they form a wave power farm. In order not to drift, the systems are moored to the seabed. Wave energy has the largest and most stable power levels in deep water, sometimes at a considerable distance from shore.

### **Best available technology**

There are an increasing number of different systems under development and initial prototype testing; so far, there has been no public comparison between these systems in terms of performance and costs. Several if not all systems have been part of the Carbon Trust study, but results are kept in generic and not specific form. Some of the systems under development are: AquaBuOY, Wave Dragon, Wave Star, Pelamis, Archimedes Waveswing, Wave Bob, Power Buoy, Wave Roller, Wave Energy Point Absorber and Limpet.

### **Supply potential**

The European wave energy potential is estimated at 320 GW, corresponding to approximately 50% of the installed capacity of European power plants.<sup>15</sup> The power levels vary from approximately 25MW/km along the continental shelf in Portugal in the south to as much as 75 kW/m off Ireland and are reduced to about 30 kW/m off Norway in the north.

If, as an example, we imagine the construction of a huge wave farm from the Canaries in the south up to Northern Norway in the north and assume the converter is able to convert 25% of the power, this would lead to an annual energy production of about 650 TWh. This corresponds to about 25% of the European electricity consumption and 5% of the total energy consumption in the EU. These values correspond well with the expected national contribution in i.e. Denmark and UK, but in countries like Ireland and Portugal, situated with highly exposed long coastlines, the contribution compared to national consumption would be much higher.

### **Environmental impact**

The technology is still in the experimental stage and there are many different types of systems, and this makes it difficult to make general comments about environmental impact. However, any wave power system disturbs the ocean environment, as the size of the waves is reduced when they pass

---

<sup>15</sup> The European Wave Energy Resource, M.T. Pontes, Third European Wave Energy Conference 1998, Patras, Greece 1998.

through the system. In some cases, this can be seen as a positive effect, preserving the coastlines from erosion. Visual inconveniences are not expected in connection with wave power systems, as the systems have a low freeboard and are placed at a distance of more than 10-100 km from the coasts.

### **Economy**

As part of the study carried out by the Carbon Trust in the UK, the future economics of Ocean Energy was studied and published in 2006. The conclusions show that, based on the present concept, the most likely central estimates of generating costs for initial offshore wave energy farms in the UK is approximately 30-33 c€/kWh.

The cost of energy can be reduced with installed capacity expressed in terms of the learning rate. The learning rate is the fraction of cost reduction per doubling of cumulative production. For example, if the learning rate is 10%, and it costs 10€ to build the first unit, the second will then cost 9€. In this way, it is predicted that after a cumulative production between 250MW up to 5000MW, the cost of energy will be reduced to 0,11€/kWh, with the learning rate assumed between 10-15%.

### **Technology lifetime**

The design life of Wave Power systems is usually 25 -30 years.

### **Interaction with the energy system**

It would seem obvious to try to get the most out of any ocean area designated for energy supply by combining wind turbines, wave systems and possibly also solar cell systems in the same area. In this way, the systems can complement each other and share an electric cable onto land. However, wave power systems are expected to be placed in deep water (above 50 meter), and, today, offshore-wind turbines are placed in relatively shallow water (below 20 meter), but in the future offshore windmills might move further out.

Wave energy and wind energy can complement each other well, as the energy production from the waves is displaced approx. 6 hours compared to the energy production from the wind. In this way, the period with wind-dependent electricity production can be prolonged – when the electricity production from the wind turbines stops, you can expect 6 more hours of electricity production from the wave power machines.

### **Geographical parameters**

The following European areas are particularly suitable for establishing Wave Power plants: Portugal, Spain, France, UK, Ireland, Norway, the Danish part of the North Sea (15-20 kW/m), the Mediterranean (5-10 kW/m).

### **Advantages**

- The globe is covered by 70 % ocean and thus, Wave Energy is a global energy source. The resources are almost infinitely large in a situation where innovative companies have worked out the most efficient system types, which can produce energy at a reasonable price.
- Wave power systems do not produce emissions or use fossil fuels.
- Electricity production through wave systems is more predictable than, for example, wind turbines, which will make it easier to integrate wave power electricity in the overall electricity system.
- Wave farms can help restore fish breeding grounds as certain areas will be restricted for fishing and wave structures can attract fish.

## Disadvantages

- A wave power system is costly to get to, because it is at sea.
- A wave power system can be a hurdle to shipping and operations regarding, for example, the extraction of raw materials and fishing – and can therefore end up competing with other business interests, when it comes to finding areas for placement of wave power systems.

## Timeline<sup>16</sup>

- 2006-2010: tests with prototype systems on the coast and at sea off the coasts of countries like Portugal, UK, Ireland, Norway, USA and Denmark.
- 2008-2015: the first smaller wave power parks are established at sea – probably off the coast of countries like Portugal, UK, Ireland, Norway, USA and Denmark. Wave power electricity can compete with electricity from wind energy with regard to price.
- 2015-25: establishment of large wave power parks around the world. An actual wave power industry, which is still growing, has been established.

## External expert comments

### Satu Helynen

Wave power is the beginning of a learning process that has been started by means of several international co-operation projects. The huge potential of wave energy makes the efforts worthwhile. The integration of offshore wind energy and wave energy seems to offer significant synergic advantages.

Wave energy seems also to be feasible as the base load energy production for some developing countries where the infrastructure for electricity has not yet been established – but of course this would be as a long-term project.

---

<sup>16</sup> The timeline requires successful prototype demonstration (both technically and economically) and massive economic investments.



## 6. Geothermal energy

### Introduction to geothermal energy

Geothermal energy is heat from the earth. It can be produced through deep wells as steam or warm water. Heat can also be produced from layers close to the surface using heat pumps, for example from layers heated by the sun. Only geothermal energy from the Earth's interior produced through deep wells is described below.

This energy can be produced by drilling deep wells to permeable layers containing warm water, pumping the water to the surface, transferring its heat to a district heating network and pumping the cooled water back to the aquifer. The temperature at the surface of the earth is close to 10°C whereas the temperature of the melt in the Earth's interior below the continental plates is around 4000°C.

There is thus a constant flow of heat from the Earth's interior towards the surface and a temperature increase with the depth of typically 25-30 °C per km. In areas of volcanic activity, hot lava accumulations may increase the temperature levels. The energy in the Earth's oil and gas reserves is small compared to the geothermal energy – and the temperature increases with the depth everywhere on Earth. The cost of producing geothermal energy does, however, vary a lot from place to place.

Geothermal energy can be used for district heating over a broad geographical area where the heat demand is big enough and production costs are low enough. Geothermal heat can also be used for desalination of seawater, heating greenhouses, district cooling, spa and agricultural processes. The geothermal production can be combined with heat storage, cooling systems and injection of CO<sub>2</sub>. Production can be increased using heat pumps and operating costs for the heat pumps can be reduced using absorption heat pumps. However, the costs of the deep wells and the surface facilities are often only financially viable where a big district-heating network is involved.

Power production is generally limited to special locations where volcanic activity has increased the temperature level in the ground and sufficient amounts of hot water or steam can be produced.

Power can also be produced from hot water in warm sedimentary layers in areas with more a normal temperature gradient, or from water pumped into cracks in the basement (hot dry rock), but not yet at competitive prices.

### Technology information

Geothermal plants use the heat from the Earth's interior to produce heat or power. The most widespread use of geothermal energy is for district heating, where a submersible pump in a 1-3 km deep well pumps 30-100° warm water to the surface, heat is transferred to a district heating network through heat pumps and/or heat exchangers, and the cooled water is filtered and reinjected through an injection well. It is pumped back to the layers it came from as it is usually too salty to be used directly and also to maintain the pressure.

Geothermal plants may be used to store heat from cooling systems reversing the geothermal loop flow in the summer time. Excess heat, for example from incineration plants, may be stored in the same way or better in an additional storage well increasing the production capacity and storage efficiency. Power may be produced from steam using steam turbines. A secondary loop may also be used to increase the power production and to avoid corrosion and scaling in the turbines.

Areas suitable for heat and power production are found using general geological information, information from nearby wells and seismic investigations etc. Aquifers suitable for heat production are widespread and could e.g. be layers of sand from the bottom of a sea present there millions of years ago. Steam and hot water accumulation suitable for power production is more difficult to find.

The technology for producing geothermal energy for district heating and power can be described as ready for use. However, there is still a need to improve the knowledge about aquifer properties. Geothermal energy will also benefit from further development of heat pump technology and corrosion/scaling control.

### **Best available technology**

Italy began producing electricity at geothermal plants about 100 years ago. Hot springs have been used for baths for thousands of years and geothermal heat is now produced at a number of locations in the EU. Many wells have been drilled, for example, nearly 800 wells with geothermal installations in Hungary". Several wells have been closed down, but a lot of expertise on geothermal aquifers, corrosion and scaling control and surface facility design can be found within the EU. Several plants have faced problems concerning re-injection of geothermal water into sandstone aquifers, for example from insufficient filtering, air ingress or the injection of corrosion or scaling products or "dirt" in the injection well. Such problems can, however, be avoided. A geothermal plant in Denmark, for example, has injected geothermal water with 15% saline at low injection pressures into a sandstone aquifer since 1984.

Geothermal heat production can be enhanced by using heat pumps or lowering the temperature level of the heating systems as demonstrated in France. Corrosion problems may be solved by avoiding air ingress, but sometimes inhibitors or a special casing material is needed to avoid it. Inhibitors may also be needed to avoid scaling. They are for example used to avoid corrosion in France and to avoid gypsum precipitation on a geothermal plant in Lithuania.

Heat pump operation costs can be reduced by using absorption heat pumps such as those demonstrated in Denmark where heat from a combined heat and power incineration plant is used to drive absorption heat pumps on a geothermal plant. All of the driving heat for the absorption heat pumps is transferred to the district heating network together with the heat from the geothermal water. Absorption heat pumps can also be used for cooling using geothermal heat to run them. Geothermal plants can be combined with heat storage, and power can be produced from geothermal water at moderate temperature levels – even below 100°C using an OCR or Kalina process as demonstrated in Germany.

### **Supply potential**

The resources of geothermal heat are huge and there are geothermal resources nearby and under many cities that can cover a large part of the heating demand for several hundreds of years, and thereafter the geothermal heat would be produced from the near vicinity and transported to the city in pipelines, until the natural heat flow after several thousand years has replaced the heat extracted closest to the cities.

Geothermal heat is best suited for heat production in the base load region due to the combination of high investment costs and low operating costs. A goal could be to cover 20 % of the heating demand in suitable larger cities and even more in suitable smaller cities.

The potential in power production is more difficult to assess, but it is highly dependent on the future development of the power costs and technologies to produce power both from Hot Dry Rock and sedimentary layers at moderate temperature levels – and the development in electricity costs from alternatives such as wind turbines and wave energy.

### **Environmental impact**

Geothermal plants reduce pollution due to substituted heat or power production. The production of power used at geothermal plants for pumping the geothermal water etc. may, however, cause some pollution to be subtracted from the potential environmental gains.

Geothermal power plants may emit gasses to the atmosphere if not reinjected. The production of geothermal water without reinjecting the water may lower the ground pressure and sometimes also lower the ground water level.

In order to remove increased concentration levels of particles in the geothermal water when starting production, the geothermal water may initially be let out into the sea or rivers. This reduces filtering costs and helps to avoid reinjection of air contaminated salty water. The particles are normally harmless (sand and corrosion products), but the temperature and salinity impact must be assessed. The energy payback time for a geothermal system is short, probably a few months.

### **Technology lifetime**

A geothermal plant producing heat can, for example, be designed to produce for 20-30 years before cold water from the injection well reaches the production. A new production well can then be drilled with an option to use the old production well as an additional injection well. Submersible pumps must typically be replaced every 4-7 years. Other components may have a lifetime like that of normal district heating network components when not exposed to corrosion or scaling from aggressive geothermal water. Wells may be usable for 30-60 years when not exposed to aggressive geothermal water.

Plants for power production may have a lifetime of a few years if they prematurely run out of hot water/steam. They may also have lifetimes exceeding 20 years – in such case often with some infill drilling and exchange of surface facilities during the years.

### **Economy**

The business economics of a geothermal system depends on many factors. Geothermal plants are characterised by high investment costs and low operating costs and are thus best suited for base load heat production.

For plants producing heat to a district heating network the operating costs depend on the permeability, depth and temperature of the aquifer from which the geothermal water is produced. Maintenance costs and cost of electricity and driving heat (if any) for absorption heat are of importance. The required temperature level for the produced heat and the number of annual operating hours are important. Exploration risk and interest rates are also important. There are large local variations in the production price of geothermal heat. The total costs for geothermal heat produced to a district heating network at a suitable location are, however, often at 0,022-0,044 €/kWh (22-44 €/MWh).

For exploration costs of power producing plants, the temperature levels and the amount of producible steam or hot water become more important – it is produced where the calculated end results are considered competitive.

### **Interaction with the energy system**

Power production from geothermal plants is easy to integrate as it can be produced whenever it is needed and can normally be transported using an existing electric grid. Some geothermal plants are combined heat and power plants.

Heat is costly to transport and it must therefore be produced close to the users. Geothermal plants for district heating can be seen as competitors to combined heat and power, but also as supplementary heat producers. Geothermal plants can produce heat with about the same efficiency as combined heat and power plants in periods with excess heating capacity from power production and with much higher efficiency the remaining part of the year.

Geothermal plants can produce heat with a high efficiency and without CO<sub>2</sub> emission using power from wind turbines and heat from biomass driving absorption heat pumps. Combined heat and power plants use less fuel than separate boilers and power plants, but geothermal heat and wind turbines combined can save even more fuel.

### **Geographical parameters**

Power production is normally only possible in volcanic areas with hot water/steam accumulations, but research is ongoing to enable power production from granite basement and areas where only moderately increased temperature gradients are possible.

Geothermal heat is normally produced from sandstone or fractured limestone. Heat production is possible at larger towns and cities suitable for district heating over a broad geographical area.

Geothermal heat can be produced where it is competitive to the local alternatives or chosen for political reasons to save hydrocarbons and reduce emissions.

The heat demand per capita is lowest in the southern part of the EU and geothermal heat production may there require access to extra large heating networks or need to be combined with geothermal power production or district cooling and/or only be produced where water temperatures are high and production costs low.

The EU has financed a geothermal atlas with information about geothermal production potential in the EU. Heat production costs including interest and depreciation on the investment do, however, vary a lot from place to place and must be calculated separately for each location.

### **Advantages**

- Pollution-free heat production, apart from pollution associated with production of electricity used to run the system
- Pollution-free power production apart from the release of gasses if they are not re-injected.
- Low running costs and low consumption of power and primary energy.
- Available at all times
- Can be combined with, for example, heat storage and cooling systems
- Competitive at suitable locations at existing price levels within the EU
- Local production of local resource involving local staff
- High fraction of costs are for man hours and equipment instead of fuel import

### **Disadvantages**

- Only suitable for base load production due to high investment costs and low operating costs
- High minimum investment costs normally requires access to a big heat demand close to the production site such as a district heating network using more than 500 TJ heat annually – preferably designed for heat supply at low temperature levels.

### **Timeline**

Europe began using geothermal energy for bathing and space heating thousands of years ago and to produce power a hundred years ago. Geothermal resources are much bigger than oil and gas resources and the use of geothermal energy for heat and power production will increase with increasing oil prices and environmental protection taxes on hydrocarbons. The heat production can be increased substantially with existing technology and more with further development of the technology. The power production can also be increased – especially if ongoing research succeeds in reducing the costs of creating useful fractures in the basement.

## **External expert comments**

### **Satu Helynen**

Geothermal energy has been a good example of utilising local energy resources in a sustainable way. Higher energy prices could boost utilisation, meaning that energy intensive processes and businesses, such as greenhouses, would choose their location near geothermal energy sources.

Technology for using rock as a seasonal storage facility for solar energy for heating during the winter season was demonstrated in the 80's in Finland, but the decrease in world energy prices then made these efforts uneconomical. Rising energy prices and heat pump technology has enabled ambient energy to be used at the present time for heating and cooling in several ways in Finland: cold sea water is used for the district cooling of buildings, warm ground water is used for the heating of homes, etc.

Efficient utilisation of low temperature geothermal energy for heating requires heating systems that can utilise much lower temperatures than conventional heating systems. This is a general observation governing the utilisation of several renewable energy sources: the most efficient utilisation requires some changes to the conventional energy system, such as lower temperature levels of heating or a demand for seasonal energy storage facilities.



## 7. Bioenergy from biomass

### Introduction to bioenergy

There are many types of biomass, as shown in the table on next page, which can be used in many different ways. Today, bio energy is estimated to cover 11-14 pct. of the world's total consumption of energy, but in Europe (EU-25), biomass constitutes less than 4% of the total energy consumption. The majority (81%) of the energy from biomass comes from the use of wood and energy crops in power or combined heat and power plants but also to a very large extent from private wood burning stoves. The use of municipal solid waste constitutes around 13% of the biomass used for bio energy.

Biomass can be converted in a variety of ways/processes into heat, power or liquid bio fuel for transportation (e.g. biogas, bioethanol, biodiesel). At present, the majority of biomass is used for heat and power production. However, the transportation sector has an increasingly large share of the total energy consumption in Europe, and liquid bio fuel produced from biomass is at present the only alternative to fossil fuel. The EU has decided that all member countries, as a recommended objective, are to replace 2% of their consumption of fossil fuel before 2005 and this should increase to 5.75% before 2010.<sup>17</sup>

The simplest conversion of biomass into energy is through burning it in stoves in private households, thereby generating heat. Although simple and low in investment costs, the efficiency of this process can be relatively high (above 80%). The impact on the local environment of using biomass in private stoves can, however, be high, due to the emission of dioxin, poly aromatic hydrocarbons (PAH), particles, etc. Combustion of biomass in centralised power plants ensures efficient cleaning of the smoke and the biomass can be used for both heat and power production. Combining the two processes enables a better efficiency (up to 90%). However, combined heat and power production require that the heat can be delivered to a district heating grid or to nearby industries with a large demand for heat/steam. Construction of combined heat and power plants is therefore linked to large investment costs and a good infrastructure for distributing the heat and power.

An important issue is biomass supply. Many conversion technologies compete for the same feedstock. Estimating the potential production of, for example, bioethanol is therefore dependent on the growth of other sectors like heat and power production. Energy produced from biomass also competes with other energy sources and the production price is therefore crucial. The cost of biomass is the largest single cost for most conversion technologies and increasing biomass demand can influence prices. Optimal and sustainable use of biomass requires short transportation times/distances, as biomass is bulky and expensive to transport. Local shortage of feedstock supply should therefore be carefully considered when planning new biomass plants. However, many technologies, which are still at the research stage, take advantage of integrating several systems, thereby maximising the energy yield and economy of the process. One example is co-production of bioethanol from lignocellulose biomass together with heat and power at a combined bioethanol and power plant.

There is plenty of biomass available. Within the EU, there are 137 million hectares of forest and 179 million hectares of cropland. Besides producing food, wood products, paper, etc., there is annually a biomass surplus corresponding to 8 EJ or 2200 TWh of energy (= 11% of EU total energy consumption). Furthermore, it is expected that using high yielding energy crops and set-aside land could further increase the biomass supply. The EU target set for 2010 aims at doubling

---

<sup>17</sup> Biofuels Directive, EC 2003/30EC.

the amount of biomass produced from the 2003 level. This can be achieved by exploiting many yet unused resources (wood residues, agricultural residues and municipal solid waste) and by growing energy crops.

The desire for a more sustainable energy supply, the questions about security of supply and climate changes, as well as the large technological progress made in processing biomass for energy purposes, has made bio energy a key area in the energy supply of the future. It has been estimated that there is significant potential in upgrading biomass to the kind of fuel that can be used in conventional energy systems – including developing crops to become actual energy sources. In theory, bio energy could cover the total energy demand. However, in practice, the possibilities are limited by the costs and by the unequal distribution of available arable areas compared to the demand.

A realistic estimate is that approx. 25% of the expected global energy consumption will come from bio energy in 2050. However, this presupposes a significant change in global policy in the energy area. At the same time, bioenergy on that scale requires significant areas of land for growing the necessary biomass. In South Africa, Africa and Asia, there are areas available, but also set-aside land in the western world could be used. However, bioenergy on a large scale cannot be carried out without extensive political initiatives, as there are significant barriers with regard to technology, economy, infrastructure, area requirements and crop-growing that have to be overcome first.

Below is an illustration of some of the many different ways that biomass can be processed, and examples of the use of the fuels. Some types of biomass (e.g. manure) are predominantly used for one type of conversion process (biogas production), whereas other types of biomass can be used in numerous systems (e.g. wood). The overview is not exhaustive.

Wood	Gasification systems	Biomass-powered heat and power station	Electricity
Straw	Biogas plants	Stirling engine system	Heat
Organic waste	Biooil systems	Biogas- or biooil-powered boiler system	Electricity
Livestock manure	Bioethanol systems	Gas turbine system	Heat
Residual sludge		Fuel cell system	Heat
Oil-containing seeds		Gas or biooil engine system	Electricity
Sugar- and starch-containing crops		Diesel engine (biooil) Petrol engine (bioethanol)	Heat

The following pages contain a description of biogas plants, biomass-powered heat and power stations and bioethanol systems. Many other technologies exist or are under development. However, the selected systems are at present already in use on a large scale or are close to coming into operation. Furthermore, these systems are already predicted to have a significant impact on the future energy supply in Europe. For more detailed descriptions of system types other than the three that are described in the following pages, see "References and links" at the back of the catalogue.



## 7.1. Biogas plants

### Technology information

Biogas is produced during anaerobic digestion of organic material, which can be sewage sludge, agricultural wastes and the organic fraction of industrial and municipal wastes. Biogas can be extracted from existing rubbish dumps (landfill gas) or it is developed under hermetically sealed conditions in a reactor tank that has been heated to 20-60C to increase the speed of transformation. This is done either at farm plants varying in size of production from 5-50 tons of slurry and organic waste per day, or at larger shared plants or sewage treatment plants. Farm plants are established and owned by farm owners, while shared plants are established by co-operative societies, private or public limited companies, independent institutions or municipalities. There is a tendency towards larger plants due to their better operation, performance and economics. To improve the gas production and the economic situation, especially at farm plants using manure, organic industrial waste (e.g. slaughterhouse waste) is added – co-digestion. However, as easily degradable wastes become scarce, energy crops like corn, barley or grass are being introduced.

The biogas which is produced consists of 60-70% methane, 30-40% CO<sub>2</sub> and 0-0.5% hydrogen sulphide. The heat value of biogas is the same as the value of natural gas when the lower content of methane is taken into account. Biogas can therefore, after cleaning for, for example, hydrogen sulphide and ammonia, substitute natural gas in a number of applications. In countries like Sweden and Switzerland, biogas is used as transportation fuel for cars, buses and trains. Biogas is also introduced into the gas grid. However, most typically, biogas is used as fuel in a gas engine that produces electricity and/or heat – either at individual farms or in heat and power stations. The electricity is then sold to the grid and the heat can be used for regional heating.

### Best available technology

Biogas technology is well established. Numerous smaller farm plants are widespread in most member countries. Larger biogas plants are also operated in many countries and there is an established industry delivering complete systems. Many conditions determine whether a biogas plant is economically efficient both business and production-wise. For example, the ability to make industrial agreements on the delivery of waste resources is a crucial economic requirement, as organic waste has a much better gas potential than slurry. Furthermore, there are significant financial advantages, the larger the plant is.

### Supply potential

Biogas plants are able to use a wide range of materials and therefore have a huge potential. Within the EU countries, 64% of biogas comes from landfill gas, 18.8% from sewage sludge gas and 17.2% from other biogases (farm plants etc.). So far, farm plants or plants utilising agricultural wastes have in many countries not been fully exploited, e.g. France with its large agricultural sector has only a very small production of biogas from agricultural wastes. In the new member states, biogas is so far also only very sparsely employed. Due to large agricultural production and the increasing need for the efficient treatment of sludge, etc., in many of the new member states, biogas production has a great potential in these countries.

Addition of organic industrial wastes to manure in co-digestion can significantly increase biogas production, but the supply in some countries is starting to be scarce due to more biogas plants being constructed. Various energy crops can also be added, thereby increasing the potential. Finally, the treatment of sewage sludge and municipal wastes represents a large source for biogas production.

In 2005, the total biogas production within the EU corresponded to around 210 TJ (58 GWh) of energy. This is an increase of 16% compared to 2004. With the current trend, the estimate for 2010 is a production of almost 400 TJ.

### **Environmental impact**

The use of biogas for energy production reduces the use of fossil fuels. Furthermore, biogas production reduces emission of the greenhouse gasses CO<sub>2</sub>, methane and nitrous oxide to the atmosphere, as a large part of these gasses are extracted from the manure and the biogas is subsequently combusted.

The degassed biomaterial from gas production can be used as manure, which may reduce the use of artificial fertilizer. The manurial value of degassed manure is known very precisely, which makes it easy to use in the fields in exactly the right amounts– this will reduce pollution of the water environment with nutrients.

### **Technology lifetime**

Production of biogas is well established and the technology is relative mature. The lifetime of the plants is therefore expected to be long. Plants established in the 80's are still in operation. The largest development is likely to be seen in technologies for converting biogas into electricity, heat, etc. New technologies for upgrading biogas to gas for transportation fuel or introduction into the gas grid are likely to improve and reduce the production price of these products. Fuel cells like solid oxide fuel cells (SOFC), using biogas as a fuel, have the potential of reaching electric efficiencies of close to 50%. Reforming of biogas to produce hydrogen that can be used in PEM fuel cells is also not yet a mature technology.

### **Economy**

Biogas can be sold as gas or converted at the plant into electricity and/or heat. Biogas production is in many countries state-supported and a fixed tariff for gas, electricity or heat is guaranteed. The main part of the biogas is converted into electricity and production of electricity is therefore the main income for most biogas plants. The tariff can be graduated depending on the size of the plant and the feedstock used.

As an example of the system and the price levels, in 2006 in Germany, electricity from biomass was guaranteed 0.116 €/kWh at plants smaller than 150 kW, 0.096 €/kWh between 150 and 500 kW, 0.864 € between 500 kW and 5 MW and 0.815 € between 5 and 20 MW. An extra payment of 0.04-0.06 €/kWh can be added if energy crops or manure are used, 0.02 €/kWh is added in the case of combined heat and power and an additional 0.02€/kWh if innovative technologies are used.

Electricity made from biogas from rubbish dumps or sewage sludge makes between 0.645 and 0.744 €/kWh in 2006. Also in other countries, electricity from biogas makes around 0.07-0.1 €/kWh.

The economy of biogas plants is the sum total of many variable factors. The most important conditions concern the size of the plant, the available biomass in the shape of slurry and organic waste, and the gas potential of the biomass. At the same time, factors such as size of the payment for the organic waste supplied and the local energy selling possibilities, including price and amounts, play an important part in the economy. Furthermore, new plants vary significantly in quality and price. Especially the quality of the products can be measured in relation to the expenses for running the plants. Altogether, this means that a biogas plant at the acceptable end of the scale would usually have a fairly good economy.

### **Interaction with the energy system**

Biogas is quite versatile as it can be used for production of heat, electricity, transportation fuel or it can be introduced into the gas grid. Biogas can be sold to decentralised heat and power stations and in the long term, it can replace a significant part of their fuel needs. Biogas plants are therefore able to interact with the current energy system. Furthermore, it is possible to use residual products from bioethanol production in the production of biogas. Some of the current fibre residues from farm plants could also be used as feedstock in bioethanol plants. See the passage about bioethanol.

### **Geographical parameters**

Biogas production is already widespread in the EU. The largest producers are (in order of production): UK, Germany, Italy, Spain and France. Generally, the biogas in these countries originates from landfill gas or sewage sludge gas. In Germany, the largest part of the production is from farm plants. Due to the general flexibility of biogas production – both with respect to feedstock, plant size and valorisation, there are no geographical parameters that limit the implementation of biogas at most locations in Europe. However, the type of biogas plant may vary due to regional differences and feedstock availability. At present, biogas is only sparsely used in the new member states (the Baltic countries, Poland, Hungary) and considerable expansion can be expected in these countries, as investment costs are relatively low and there is a large potential feedstock supply.

### **Advantages**

- Biogas production can be used for treating a number of waste streams from agriculture, industry and households.
- Biogas plants can also contribute to reducing the emission of strong greenhouse gasses like methane, etc., to the atmosphere.
- The residual product in the shape of degassed manure has a much higher manurial value than unprocessed livestock manure.
- The obnoxious smells of livestock manure and other organic waste are reduced significantly when the manure has been processed in a biogas plant.
- The use of biogas reduces the use of fossil energy and, in the long term, it will reduce the need for import of fossil fuels, which will improve the supply security.

### **Disadvantages**

- There can be obnoxious smells in connection with the handling of biomass. However, the problem has basically been solved with the development of biogas plants.
- There are relatively large transport costs connected with biogas production in large shared plants. 35-50 pct. of the operating costs in a shared plant can usually be attributed to the transport of biomass.

### **Timeline**

- 2010: doubling of biogas production compared to 2005. Joint production of biogas and bioethanol. Use of energy crops in biogas production.
- 2015: widespread use of biogas farm plants in many member states. Biogas production 5-10 fold higher compared to 2005.
- 2020: reforming of biogas to hydrogen for use in fuel cells.
- 2030: large parts of the gas demand could be supplied from biogas.

### **External expert comments**

#### **Satu Helynen**

Biogas plants are typically not just energy investments; they are not only generating heat and electricity, but offer significant environmental benefits, such as utilising residues and waste, thus minimising effluents to lakes, rivers and seas or avoiding landfilling.

Biogas plants can offer farms, the food industry and the waste management sector additional earnings as an energy producer. Energy can be electricity and district heating supplies to a near-by community, or fuel for the buses in local traffic or trucks belonging to a waste company.

Microturbines and gas engines are available for electricity production, and when fuel cells are competitive in operation, the efficiency of electricity generation will increase significantly.

## 7.2 Biomass-powered heating and power plants

### Technology information

Biomass was used to produce 1,750 PJ of heat and power in the EU in 2002. Wood is by far the most used type of biomass for production of heat and power. Solid biomass in the shape of wood is used to a great extent as fuel for heat and power production in the Scandinavian countries.

In Finland, the largest producer of electricity from wood in Europe (9.9 GWh in 2004), wood energy represented 20.5% of the primary energy consumption in 2004. Use of wood is more prevalent in countries with forestry and a large forestry linked industry (Finland, Sweden and Austria). In countries like France, Germany and Spain, the use of wood is restricted to those areas with forestry.

In Denmark, solid biomass also includes a large portion of straw and Denmark is among the leading countries in technologies for the handling and combustion of straw in large-scale Combined Heat and Power Plants (CHP).

In the longer term, there is estimated to be increased potential for the expansion of biomass as fuel, for example through the development of special energy crops that can optimise production.

### Best available technology

There are many different types of systems in use, depending on the size of the plant and the type of biomass used. For smaller systems, fixed-bed combustion is frequently applied, whereas larger systems (usually above 30 MW) use fluidised bed combustion.

Use of wood or straw pellets can often easily be used for co-firing with coal in existing power plants, thereby capitalising on the large investments and infrastructure associated with the existing systems. Agricultural residues like straw are much more difficult to handle in the system, due to high content of ash and especially alkali salts. Upon combustion, these salts generate corrosive compounds, which destroy the boilers, heat exchangers and flue gas cleaning system. The Danish Avedøre II Plant and the Spanish Sanguesa Plant represent some of the latest technologies for conversion of straw into CHP.

The overall highest efficiency level for a plant is to be found where there is combined heat and power production. For larger plants operating with steam turbines and super heaters, electricity efficiencies up to 40-45% can be reached. Using the low temperature steam afterwards for, for example, district heating can bring the total efficiency up to around 80-90% in the best case. However, over the year, fluctuations due to the high demand for electricity and low demand for heat during the summer period reduce the efficiency.

Due to the bulky nature of biomass, road transportation is expensive. Transportation of biomass over long distances is therefore uneconomic and negatively affects the carbon and energy balance.

### Supply potential

Since the ending of the 1980s, the market share of biomass systems producing electricity has risen significantly. In Europe, electricity production from biomass increased by 23% to 35 GWh from 2003 to 2004.

Denmark is one of the most advanced countries in the world when it comes to practical operational systems and demonstrations in the field of biomass production. With the current Biomass Agreement<sup>18</sup>, Danish power stations are obliged to use 1 million tons of straw and 0.4 million tons of wood chips per year from 2005.

---

<sup>18</sup> In Danish: [http://www.folketinget.dk/samling/20001/udvtilag/epu/1205\\_bilag17.htm](http://www.folketinget.dk/samling/20001/udvtilag/epu/1205_bilag17.htm).

Biomass accounts at present for 13% of all fuel inputs to CHP in the older EU member states, whereas in the new member states, the share is only 1%. In these countries, there is therefore a large unexplored opportunity to increase the use of biomass for CHP.

Today, biomass for CHP is mainly in the form of wood or wood residues. Results obtained in Denmark indicate that those agricultural residues in the form of straw can potentially be used.

### **Environmental impact**

The use of bio-energy crops for heat and electricity production could efficiently reduce the greenhouse effect by replacing fossil fuels. The biggest reduction of carbon dioxide emission is obtained with combined heat and power production with very high efficiency rates and a careful selection of the optimum plant location in order to reduce transportation.

Biomass incineration generates a certain amount of dangerous waste that results in acidification of the environment and inert waste products. However, the environmental impact is less than the impact of incineration of fossil fuels. Wood is the most environmentally friendly bio fuel for incineration, while plant biomass, such as straw, has a larger content of nitrogen, sulphur, potassium, chlorine, etc., which results in the increased emission of ozone layer-degrading materials, as well as increased corrosion of the system and increased precipitation of clinker.

### **Technology lifetime**

Many existing coal-fired power plants or CHP can be rebuilt for co-firing with biomass. New coal-fired plants are also constructed to enable co-firing. Wood has been used for many years and the technology is well proven and established. Combustion of straw is established to a lesser degree and new technologies for handling, pre-treatment and combustion of straw are currently emerging. It is expected that the traditional combustion technology will still be the dominating technology for transforming biomass into electricity and heat for many years. Today's technologies are capable of operating with very high efficiencies and have a long lifetime.

### **Economy**

At present, the production costs for biomass based electricity is around 0.07-0.2 €/kWh. The difference is mainly due to differences in feedstock and transportation costs. It is a core area in the 6th Framework Programme in the EU to reduce the costs of biomass-based electricity production by 0.05 €/kWh by approx. 2015-2020.

### **Interaction with the energy system**

CHP can beneficially be integrated with the production of bioethanol. The solid residues after bioethanol production can be used as a high quality fuel in CHP and excess low-pressure steam from the CHP plant can be utilised in a bioethanol plant. Integration of CHP with the production of liquid bio fuel in the form of bioethanol has been demonstrated as economically feasible in the EU research project IBUS (Integrated Biomass Utilisation System).<sup>19</sup>

In the future, it will most likely be possible to use fuel cells for efficient electricity production, when using biofuels in liquid form or as gas (see chapter on fuel cells).

### **Geographical parameters**

As already mentioned, transportation costs of biomass are high. Plants therefore have to be placed within a reasonable distance from the feedstock supply. In the Nordic countries with large forest areas, wood is already used to a large extent. But in the Baltic countries, and especially Estonia,

---

<sup>19</sup> [www.bioethanol.info](http://www.bioethanol.info).

which has a large forest area, there is a great possibility to build or change existing coal-fired plants into plants operating with biomass, eventually in co-firing.

In the new member states, old coal-fired power plants could beneficially be exchanged with new CHP plants using biomass (wood, straw or energy crops). The remaining European countries' CHP plants using biomass could be placed either in regions with forestry or in agricultural regions where agricultural residues like straw, corn stover or energy crops could be potential feedstock.

### **Advantages**

- Use of biomass for heat and power production increases the supply security by reducing the need for fossil fuels.
- Small decentralised CHP plants can be placed near the feedstock supply and thereby generate power and heat for district heating.
- The greenhouse effect is reduced, as fossil fuels are replaced.
- Some existing coal-fired power plants can be upgraded to using biomass, thereby reducing the investment costs

### **Disadvantages**

- The relatively high price of small systems.
- High capital costs of new plants
- Expensive to establish district heating in new areas

### **Timeline**

- 2010: continued establishment of heat and power stations based on biomass. Energy crops used in CHP.
- 2015: CHP integrated with bioethanol production. Gasification of biomass for production of hydrogen for fuel cells.
- 2020: CHP integrated with biorefineries for co-production of fuels and chemicals
- 2030: CHP either in large plants integrated with biorefineries or small local decentralised plants

### **External expert comments**

#### **Satu Helynen**

Biomass-powered heat and power stations have been widely used in district heating systems in municipalities and in process industries in Finland since the 70's and they presently cover about 10% of the electricity demand in Finland. They operate competitively in the open electricity market. The smallest plants have received investment subsidies and all the plants have received very moderate bonuses, 0.4-0.7 cents/kWh, on renewable electricity. Taxes on fossil fuels for heating have increased the value of heat generation, which has been an important factor for the economy. Well-proven technologies include grate and fluidised bed technology in capacity ranges of 1 – 200 MW electricity). In the near future, fixed and fluidised bed gasification of solid biomass will improve power-to-heat ratios on a small scale, and IGCC on a large scale.

The economic transportation distances for biomass, like forest chips and pellets, have increased considerably when rail and waterway (sea, lakes and channels) transport has been utilised instead of

road transport in Finland. The possibility of using a wide range of fuels in a CHP plant is the best guarantee for the availability of competitive-cost fuel during the total lifetime, 20-30 years, of the plant. It is important that competition in the biomass-fuel market is open and the number of operators is high.

Pellet production has been integrated into several combined heat and power plants in Finland. In the near future, the production of pyrolysis oil to replace fossil oils and the production of Fischer-Tropsch fuels, synthetic natural gas or hydrogen based on thermal gasification of biomass, will be integrated into CHP plants.



## 7.3 Biofuel systems

### Introduction to biofuels

Biofuels for use in the transportation sector can be divided into biodiesel and bioethanol, the later often used for mixing with gasoline. Both are derived from biomass, but biodiesel is produced from the seeds of oleaginous plants like sunflower or rapeseed, whereas bioethanol is produced from the starch or lignocellulose from grains or straw, wood or plant waste.

Biodiesel (or vegetable oil methyl ester) is produced by esterification of plant oil with methanol thereby producing the biodiesel and glycerine. In Europe, the main raw material is rapeseed, but e.g. sunflower seeds can also be used, although rapeseed oil is considered to produce biodiesel of better quality. The glycerine is a valuable by-product for the chemical and cosmetic industry. Another by-product is the press-cake from the pressing process, which is a protein rich product used for animal feed. The production process is relatively simple, the technology is well implemented and has been running on industrial scale in EU since 1992.

EU is the world largest producer of biodiesel with a production of 3.2 million tons in 2005, three-fold more than in 2002, and an expected production of around 6 million tons in 2006. The biggest producer is Germany with around 50% of the EU production in 2005. France, Italy and Czech Republic are on the next three places with around 15, 12 and 4%, respectively, of the production. The biggest producer is Diester Industries (France) with an expected capacity of almost 1 million tons in 2008.

Bioethanol produced by plant materials make up 60% of the world's total ethanol production. Starch-containing crops such as maize, sugarcane and grain are used in the bioethanol processes that are commercial today, and today this technique is quite advanced and widespread. This technology is referred to as first generation bioethanol technology.

The largest bioethanol-producing countries in the world are Brazil and the USA. Europe is responsible for 13% of the global production, and the production is increasing because many European countries have started extensive bioethanol programmes. In 2005, European production was around 720,000 tons of bioethanol, a three-fold increase since 2000. The biggest producers are Spain, Sweden, Germany and France.

In Europe, bioethanol producers are often the sugar and alcohol industries. In Spain, Abengoa has the biggest production capacity in the EU (345,800 tons), followed by two German companies with capacities of 245,000 and 205,000 tons respectively. Rapid expansion of the production capacity and the wish to utilise cheaper feedstock has resulted in extensive research to develop second generation bioethanol technology, based on the utilisation of lignocelluloses material like wood and straw.

### Technology information

Biodiesel production from plant oils is already well established with production in most EU- 25 countries. As the production can be based on simple technology the plant size varies greatly in size. However, the biggest and most advanced plants typically have capacity around 200-250,000 tons annually, but small plants around 50,000-100,000 tons annually are also common. The esterification process run with efficiencies of 95-99% and the main challenges are related to improving the

extraction process and to secure the quality of the final product, which has to meet the specifications given by the EU standard EN14214 (comparable to the German norm DIN51606). Typically, one ton of rapeseed results in 300-350 kg of biodiesel. Research is ongoing on improving extraction of the oil and esterification employing enzymes. The possibility of using ethanol (bioethanol) instead of methanol for the esterification is also a research object. The separation of biodiesel and glycerine after the esterification is an important issue as impurities in the glycerine reduces its value and applicability in different processes.

First generation bioethanol technology is well established and these plants are operating on a large scale in many places around the world. A typical plant production is around 150,000-300,000 m<sup>3</sup> of ethanol per year. With present technology, conversion yields are already high, but new enzymes and optimisation of processing conditions can result in higher productivity and reduce energy usage, thereby improving the economy and the energy and carbon balance.

### **Best available technology**

Over the last few years, important developments have been achieved through implementation of second generation bioethanol technology in which lignocelluloses biomass, i.e. the whole plant, has been converted into bioethanol. Using lignocelluloses materials, for example, together with starch containing cereals, results in a much higher total energy produced per hectare of land, an overall higher reduction in carbon dioxide emission and a more sustainable process.

In Örnsköldsvik in Sweden, a pilot plant for conversion of wood residues (sawdust) into bioethanol was started up in 2004.<sup>20</sup> Another large pilot plant mainly operating with straw was put into operation in Denmark in 2005.<sup>21</sup> This plant is located at a Combined Heat and Power Plant (CHP) and the intention is to study and prove the feasibility and possibilities of co-production of bioethanol with CHP. A third pilot plant placed in Denmark for co-production of bioethanol and biogas is expected to come into operation in autumn 2006.

The process of producing bioethanol from lignocelluloses (the non-starch-containing parts of the plant) is still at the research stage. However, with the construction of several large pilot plants in Europe and the subsequent process development, it is expected that within 2-4 years, this technology will be ready for large-scale production.

### **Supply potential**

Due to the production of biodiesel, the area used for growing rapeseed has been increasing in Europe to meet the demands. Rapeseed is the main crop used for biodiesel production in Europe and other oilseeds like sunflower and soybean only contribute little to the biodiesel production. The production potential is limited by the low yield oil per hectare (1.1 to 1.5 tons per hectare) and because only the oil seed can be used. However, growth of rapeseed is wide spread in most countries in Europe with France and Germany being the largest producers. Also the new EU member countries Poland and Czech Republic have a substantial rapeseed production. Especially in the Eastern European countries, including the new members Romania and Bulgaria, an increased production can be expected. Romania already in 2005 had export of rapeseed and rapeseed oil to the EU.

---

<sup>20</sup> [www.etek.se](http://www.etek.se).

<sup>21</sup> [www.bioethanol.info](http://www.bioethanol.info)

The production capacity is rapidly expanding in Europe. Again Germany and France are dominating. During the last five years, the production has increased 5-fold, and new plants are under construction.

In 2005, the production of bioethanol from starch containing feedstock was 720,000 tons. The production capacity is currently underexploited and, furthermore, the capacity is gradually been increased with new plants in Germany, France and Spain. It is therefore expected that production can increase rapidly in the short term, as the demand increases due to promotion of bioethanol throughout EU.

Between 2004 and 2005, the production increased by 70% and a doubling in production within the next 2-3 years is therefore expected. With the current overproduction of grain and corn within the EU, the supply potential for feedstock should meet the demand from the bioethanol industry.

In the long term, with production of second generation technology, the large unexploited resources of agricultural residues would be enough to ensure a substantial increase in production. In countries like France, Germany, Italy and Hungary with a large crop production, the residues are at present far from being exploited for energy usage. It is estimated that crop residues could potentially supply 50-70 million tons of bioethanol annually in Europe. In the near future, high yielding energy crops would enable a further gradual expansion of bioethanol production in Europe.

### **Environmental impact**

Transport's share of carbon dioxide emissions makes up approx. 20% of the total emissions (2003). In addition, the transportation sector is fast growing and accounts for more than 30% of the total energy consumption within the EU, of which 98% is from fossil fuel.

Today, the EU goal for biofuels is that the use of biofuel in the transportation sector should gradually increase from 2% in 2005 to 5.75% in 2010. In many countries, this has resulted in blending petrol with typically 5% bioethanol or ethyl tertiary butyl ether (ETBE) - an octane enhancer made from bioethanol. In countries like Germany and Austria, biodiesel is common and is used both in the form of 100% biodiesel (B100) or blended with diesel (e.g. B5).

In 2002, 40% of the cars in Europe were running on diesel and the trend is towards more diesel engines because of lower fuels price of diesel and a better mileage compared to gasoline. In France and Germany biodiesel is therefore being promoted. The advantage of biodiesel is that motor manufactures have guaranteed that the engine can run on blends of biodiesel and diesel up to typically 10 or 30%. Furthermore only small modifications usually have to be done in order to run on 100% biodiesel.

Biodiesel has some advantages compare to normal diesel. It is fast biodegradable and has low sulphur content. Studies have estimated that use of 100% biodiesel results in a 65% reduction of carbon dioxide emission compare to diesel.

Sweden has strongly promoted the use of bioethanol and it is possible to buy blends with 85% ethanol (E85) at around 400 filling stations throughout Sweden. Running on E85 requires a "Flexible Fuel Vehicle" (FFV), which can run on all mixtures between 0 and 85% bioethanol.

Many car companies (Ford, Volvo and Saab) are now selling FFV's to the European (Swedish) market. It is estimated that the extra cost of producing a FFV car is around 150 €. Gradually replacing petrol with bioethanol will reduce the net emission of carbon dioxide from the

transportation sector. A 10% bioethanol-90% petrol blend reduces the emission by 8% if made on lignocellulose feedstock.

Ethanol can replace the environmentally dangerous methyl tertiary butyl ether (MTBE) in petrol. The EU as well as the USA has started a phase-out of MTBE in favour of ethanol. Contrary to MTBE, which is not biologically degradable, ethanol is quickly degraded in soil and water.

### **Technology lifetime**

Biodiesel plants are expected to have a long lifespan. The technology is at present well developed. The lifetime of a plant is mostly depending on the durability of the machinery. Lifetime expectations can be 20-30 years.

Traditional ethanol plants have now been in operation for more than 15 years. The lifetime of a bioethanol plant is therefore comparable with other chemical facilities/plants. This means that most basic facilities and most of the equipment have a lifetime depending only on normal wear and tear. Some development in design and improvement of technology are expected, but normally these changes can be gradually implemented along with normal maintenance of the plant. Especially for the first second generation plants, some rapid improvements and needs for exchange of equipment can be expected. Otherwise, the lifetime expectation can be 20-30 years.

### **Economy**

The biodiesel price is at present competitive with diesel. However, the raw material price accounts for around 90% of the biodiesel price. Therefore the price is much depending on supplies and plant oil prices on the world market. The by-products glycerine and animal feed also contributes to the feasibility of the plant. With the increasing production of biodiesel a surplus of glycerine is produced and this leads to a reduced income from glycerine sale. The production cost is 0.6-0.7 €/l. The energy content of biodiesel is almost identical to the energy content of conventional diesel.

The price of bioethanol is highly dependent on raw materials. Plant waste is an example of a relatively inexpensive raw material, whereas starch-containing materials, like for example grain, can be expensive. The present first generation technology plants in Europe are mainly using grain and to a lesser extent corn. The current production cost is around 0.6 €/l. Due to the lower energy content in ethanol compared to gasoline, the price is equivalent to a gasoline price of 0.8 €/l. With second generation technology, including the benefits of integration with biogas production or CHP plants, the production cost is estimated at 0.3-0.5 €/l.

### **Interaction with the energy system**

The biodiesel production results in some waste that can be treated in biogas plants thereby generating electricity and heat for the biodiesel production. The yield of energy produced per hectare of area could be increased by collection of the straw and stalks and using this part for burning or bioethanol production.

The production of bioethanol results in waste in the shape of non-sugar-containing plant materials that can be used in biogas plants or combusted in CHP plants. Bioethanol can also be produced from sugar-containing by-products from biogas plants.

This kind of joint production provides optimal use of bioenergy with minimal waste production. At the same time, the production costs of bioethanol are reduced by 35%. Integration with CHP plants offers the possibility of using the residuals for heat and power production and waste heat/low temperature steam from the CHP plant can be used for much of the heat input required for the bioethanol plant. An extensive plan for integration of wind, CHP and bioethanol production has been presented in the “Retrol”-vision (“VENzin” in Danish) presented by the Danish power company Elsam.<sup>22</sup>

### **Geographical parameters**

The growth of rapeseed is at present mainly localised in the north and central European countries Germany, France, the UK and Poland. In south of Europe, the warmer and dryer climate is less well suited for growth of rapeseed. Sunflower production dominates the south and South Eastern Europe. However, the characteristics of sunflower oil makes it less attractive for biodiesel production and biodiesel produced from sunflower has difficulties meeting the EU biodiesel standard.

At present, the first generation bioethanol plants are using agricultural feedstocks like grain or corn. Countries like France and Germany have a large production of grain and both countries have bioethanol plants under construction. Spain and Italy also have a large production of grain and corn. Poland and Hungary have only 7% and 4% respectively of the wheat production in the EU, although both countries have large agricultural areas available. Hungary is the third largest corn producer in the EU. Improving agricultural practice and construction of bioethanol plants in these countries is therefore highly relevant.

With the emergence of second generation technology, the above mentioned countries will all be potentially good sites for bioethanol plants. With the large agricultural sector in these countries, large amounts of agricultural residues in the form of straw and corn stover are available. Second generation plants can also use wood or wood residues. This will enable the production of bioethanol in rich forest regions and countries (Sweden, Finland, Estonia, South Germany, etc.).

### **Advantages**

- Both biodiesel and bioethanol can be blended with diesel or gasoline, respectively, in mixtures up to 5-10% and used in conventional cars without modification.
- Biodiesel can in many cases be used in mixtures up to 30% without modifications, and can with small modifications of existing cars be used pure.
- With Flexible Fuel Vehicles (FFV), ethanol can be used in mixtures up to 85% (E85).
- Use of biodiesel and bioethanol in the transport sector can reduce CO<sub>2</sub> emission.
- Bioethanol can be transformed into ETBE and replacement of MTBE in petrol with bioethanol can remedy the problems with MTBE pollution of subsoil water.
- Both biodiesel and bioethanol are biodegradable.
- In the long term, bioethanol can reduce dependency on oil import.

---

<sup>22</sup> [www.elsam.com](http://www.elsam.com).

- Production of crops for biodiesel or bioethanol production can support the agriculture in Europe and contribute to employment in rural areas.

### **Disadvantages**

- The hectare yield of oil seed is low compared to the yield of bioethanol that can be produced on the same area.
- Bioethanol has a higher price per litre as well as a lower density than petrol – which means that a larger amount is needed at a higher price to drive the same distance.
- Use of agricultural land for energy crops can put pressure on land for food production.

### **Timeline**

- 2010: 3-5 fold higher production of biodiesel and bioethanol using first generation technology compared to 2005.
- 2010: Widespread use of biodiesel mixtures (B5 to B100) bioethanol mixtures (E5 to E85) or ETBE in almost all countries in the EU.
- 2010: First commercial plants using second generation bioethanol technology.
- 2015: 15-25 fold higher production of bioethanol compared to 2005 level - half of bioethanol production based on second generation technology.
- 2015: Energy crops dedicated to bioethanol production.
- 2020: Integrated biorefineries for co-production of fuels and chemicals.
- 2030: Potential bioethanol production could be 100 fold higher than in 2005.

### **External expert comments**

#### **Satu Helynen**

The greenhouse gas emission reductions and energy input-output balances of grain-based ethanol production are not especially good in Europe. Production of bioethanol from lignocelluloses materials, like straw and wood residues from forest industries, could encourage the utilisation of lower cost raw material and better environmental parameters. In both cases, integration of production plants into the processing industry with its CHP plants increases energy efficiency in the production of liquid biofuels,

An alternative process for the utilisation of lignocelluloses materials is thermal gasification, and production of Fischer-Tropsch-diesel fuels, synthetic natural gas or hydrogen from cleaned synthesis gas. It is obvious that several concepts will be needed because parameters connected to biomass can differ so much: Availability and price level of biomass, quality of biomass, etc. Thermal gasification is one of the technologies, which could utilise a wide range of different fuels in the same plant with continuously varying mixtures. Second generation bioethanol plants will probably be planned to utilize one main type of biomass.

## 8. Solar Energy

### Introduction to Solar Energy

Solar energy<sup>23</sup> in this context includes heat producing solar hot water systems (SHW) and electricity producing photovoltaic systems (PV). Although Europe exhibits considerable differences in insolation<sup>24</sup> – in yearly average, a factor 1:2 from northern to southern Europe and, more importantly, a seasonal variation in the north of 1:10 compared to 1:4 in the south – the potential for solar energy applications has long been recognized, and, since the early 1970's, research and development activities have seen promoted and supported on both EU and member state levels. The expectations of solar energy in Europe are high: the EU goal for SHW is 100 million m<sup>2</sup> installed by 2010 and for PV 3 GW installed also by 2010. With present trends, only half of the SHW goal can be expected to be met, in contrast to PV where more than 4.5 GW is forecasted to be installed by 2010. Solar energy applications are expected by the Commission<sup>25</sup> and most member states to contribute significantly to the future European energy supply, benefiting security of energy supply, reducing energy imports, reducing the environmental impact of the energy sector and stimulating job creation.

The two aforementioned solar energy technologies, SHW and PV, are markedly different in terms of technology sophistication, and are consequently in the following treated individually.

*SHM (Solar hot water) technology:* SHW technology is generally regarded as a simple technology well suited for manufacture by Small and Medium-sized Enterprises (SME's). Because of this, it has merited relatively little R&D interest on the EU level, as EU level intervention has been found not to provide any special added value to advancement of the technology. SHW in Europe comprises only about 10% of the world market. The EU goal, as indicated in the EU White Paper<sup>26</sup>, and the current trend is illustrated on the right.<sup>27</sup> However, SHW technology has merited strong R&D interest from most member states, and all 25 EU countries have SHW systems installed, however to a widely different degree.

Germany has the biggest capacity of the EU with a cumulated installed surface of over 6 million m<sup>2</sup> (4.3 GW<sub>TH</sub><sup>28</sup>), followed by Greece and Austria. Together, these three countries represent ¾ of the European market. Attractive public support schemes have promoted penetration in Germany and Austria and to a lesser extent in Greece. Most EU manufacturers and installers are local SME's.

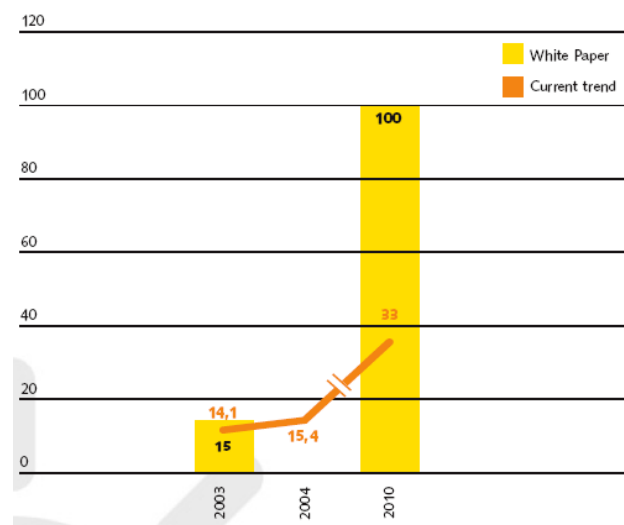

<sup>23</sup> Solar energy applications also include thermal parabolic troughs and large scale central reflector technologies, and passive use of solar energy in buildings.

<sup>24</sup> Insolation: energy content of the sunlight in terms of both direct light and diffuse light. For example: in Denmark, half of the electricity production of a PV system comes from direct sunlight, half from diffuse sunlight.

<sup>25</sup> A vision for Photovoltaic Technology for 2030 and beyond, PV Technology Research Advisory Council, EC 2004

<sup>26</sup> EU White Paper on Renewable Energies, COM(97)599, 26.11.97; EU Directive 2001/77/EC.

<sup>27</sup> Source: EuroObserver 2005.

<sup>28</sup> IEA conversion: 1 m<sup>2</sup> = 0,7 kW<sub>TH</sub>

*PV (photovoltaic systems)*

*Technology:* PV Technology has a long track record in EU R&D activities. Development of the complete value chain of PV technology lends itself to EU level intervention because of the complexities and high level technologies involved.

The EU R&D effort has been complemented by member state efforts mainly in countries like Germany, Holland and Switzerland, but lately more and more EU countries are active in

this field. PV in Europe constitutes in 2005 about 65% of the world market of approximately 1.2 GW. The EU goal as indicated in the White Paper and the current trend is illustrated above on the right-hand side<sup>29</sup>. The goal 3 GW set by the EU corresponds to about 1% of all electricity production in the EU from PV, and this goal appears to be quite modest with the present trend. In terms of countries, Germany is strongly in the lead with 0,6 GW installed in 2005 and about 1,5 GW accumulated installations. The installed PV capacity in Germany corresponds to 17,3 W/per inhabitant compared to e.g. 0,5W/per inhabitant in Denmark and 3,1 W/per inhabitant in Holland. Emerging and fast growing markets are to be found in Spain, Italy, France and to a certain extent in Greece, all with the market driven by a feed-in tariff for the PV produced electricity, constituting an attractive public support mechanism. EU industry produced in 2005 about 0,48 GW and could thus not supply the EU market. However, the PV industry in Europe is now consolidating and investing heavily in manufacturing capacity in all links of the PV value chain.

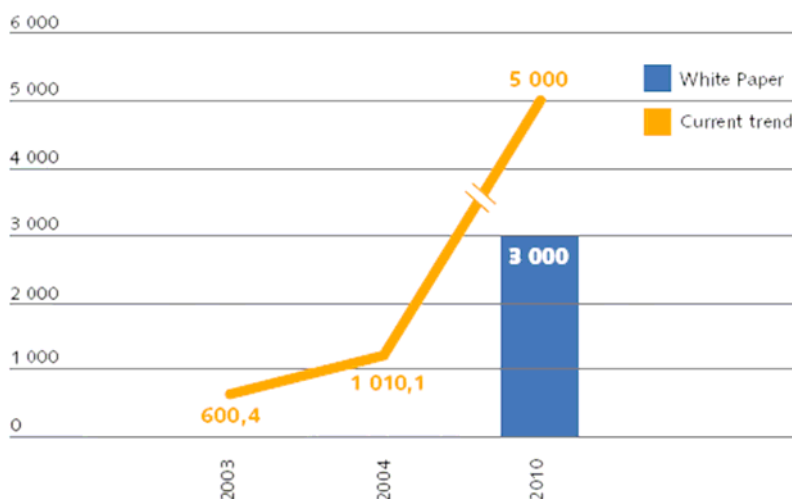

<sup>29</sup> Source EuroObserver 2005



## 8.1 Solar Energy – SHW systems

### Technology information

Solar thermal technology converts part of the energy content of the insolation into heat. Sub-technologies include flat plate collector systems<sup>30</sup> typically for domestic hot water and other low temperature applications such as space heating or large scale district heating, parabolic troughs/evacuated tube collectors for higher temperature applications such as industrial process heat, and central thermal power stations with heliostats<sup>31</sup> concentrating the insolation from a large area on a small receiver, in this way obtaining high temperatures and capacities suitable for operating steam turbines.

Typical solar thermal conversion efficiencies range from about 25-60%. The two first mentioned sub-technologies are fully commercial and in operation in many countries all over the world.

A solar heating system transforms the energy of the sun to heat, typically in a single, closed circuit. The solar collector consists of a black plate, which picks up the energy of the sun and heats up a mixture of water and antifreeze, which is pumped to a special hot-water tank in the house, where it emits the heat and runs back to the solar collector. Solar collectors are typically used for heating up domestic water, but more and more people also use solar-heated water for floor heating and other space heating. The system is adapted to the size of the house and the heating requirements.

Furthermore, a new and promising use of solar heating is being developed – solar cooling. By attaching a solar collector that can heat water to 80 to 100 degrees to an absorption cooler, it is possible to create refrigeration, which can for example be used in air-conditioning systems. As the world uses more energy on cooling than on heating, great energy-saving perspectives in the solar cooling area become available.

By the end of 2004, about 110 million m<sup>2</sup> of solar collectors were installed worldwide. The energy contribution from this technology can be calculated using the IEA adopted conversion factor of 1 m<sup>2</sup> = 0.7 kW<sub>TH</sub>. As to technology, about 25 pct. is unglazed collectors, mainly serving swimming pools, and 75 pct. is flat-plate and evacuated-tube collectors, predominantly for preparing hot water and for space heating. The average market growth rate has been 17-20 pct. in recent years. The most dynamic market areas are China and Europe. By 2004, China shows about 65 million m<sup>2</sup> installed capacity corresponding to 50 m<sup>2</sup>/1000 inhabitants. The EU exhibits about 14 million m<sup>2</sup> installed capacity with wide variation from country to country.

The presently installed solar thermal capacity provides around 0.15 pct. of the overall EU requirements for hot water and space heating. Used predominantly for hot water and space heating, solar thermal collectors are typically mounted on roofs of buildings, and as solar thermal installations are quite visible, this has led to an ongoing process of both technological and architectural development. The aesthetics of a building is one of the most important aspects when solar collectors are “integrated” into the building envelope, the main trend being to try to make the solar collectors as invisible as possible. However, architects have started to use solar thermal installations in order to enhance the aesthetic appeal of a given building, but much more research and development seems to be needed in this field.

In general, system costs decrease with the size of the system. Therefore, solar thermal systems connected to a district heating network are more cost-effective than systems for single family houses. Traditionally, short term storage is included in a solar thermal system in the range of 50-75

---

<sup>30</sup> Thermo siphon's or with forced circulation

<sup>31</sup> A Heliostat is a device that tracks the movement of the sun.

liters per m<sup>2</sup> collector. Seasonal storage in the range of 2000 liters per m<sup>2</sup> collector area has been investigated, but is still very much a research and development issue.

### **Best available technology**

Today (2006), vacuum tube solar collectors are the best with regard to performance. The somewhat higher price of these systems, compared to other product types, is usually compensated for by the better performance.

### **Supply potential**

A solar collector that covers an area of 4-5 m<sup>2</sup> can typically cover 60-65% of the annual energy consumption of hot water for a family of 3-4 people. During the summer months, a facility like this will even cover the hot water need 100%. An average system that is targeted at space heating as well as hot domestic water can typically cover 30-40% of the annual heat consumption of a household depending on the geographical region. As mentioned, the EU has an objective<sup>32</sup> that there should be 0.25 m<sup>2</sup> solar collector per citizen in the member countries in 2010, which corresponds to a total of approx. 100 million m<sup>2</sup>. However, with the present market trends, only about 40-50 million m<sup>2</sup> is likely to be reached by 2010. In 2005, Germany installed about 950.000 m<sup>2</sup> totalling 4.700 million m<sup>2</sup> (4.700 MW<sub>TH</sub>). About 4 % of German homes use SHW in 2005. Also in 2005, Austria installed about 240.000 m<sup>2</sup>, Spain almost 1 million m<sup>2</sup> and France about 120.000 m<sup>2</sup>.

### **Environmental impact**

A solar heating system does not emit any CO<sub>2</sub> or any other harmful substances to the atmosphere. An amount of power that corresponds to a light bulb is used for the system's control function and pump. Most solar heating manufacturers take worn-out systems back and reuse some of the parts. The radiator coolant used is non-toxic. The energy used to produce a solar heating system corresponds to the energy that is produced by the system during approx. 9 months of operation.

### **Technology lifetime**

An average solar heating system with a life span of at least 20 years, which is installed by a workman in a home with electrical heating, will have paid for itself through saved energy costs within 7-8 years. If the system is installed in a home with oil/gas heating, the investment will have paid for itself within 12-15 years in Northern Europe. The annual operating costs of a solar heating system make up approx. 1% of the system price. Operating costs consist primarily of the power consumption of the pump that keeps the system running.

### **Economy**

A typical single family household SHW system of 4-5 m<sup>2</sup> collector areas and 200-300 litres of storage tank ranges from 2-4000 €, but this depends considerably on the country and brand of manufacture.

### **Interaction with the energy system**

It appears from the EU's White Paper containing, amongst others, solar heating<sup>33</sup> that solar heating is assessed to have a good chance of becoming a profitable type of energy in connection with large, central heat and power stations. In 2004, the large solar heating systems that are attached to district heating stations are close to becoming a competitive alternative to gas and oil. It is advantageous to

---

<sup>32</sup> EU White Paper on Renewable Energies, COM(97)599, 26.11.97; EU Directive 2001/77/EC.

<sup>33</sup> EU White Paper on Renewable Energies, COM(97)599, 26.11.97; EU Directive 2001/77/EC.

combine solar heating systems with biofuel systems (such as wood pellet burners), which can supply heat during the winter, when the solar heating system is less active. At the same time, it is an advantage to be able to turn off the boiler – typically during the summer. A biofuel boiler burns poorly at low load operation, which results in low efficiency and thus poor heating economy. When fuelling with biofuels, it is possible to use a highly efficient boiler with an attached storage tank, where the heated water is stored for use during the day and night. It is a good idea for the supply of hot water to the storage tank to come from a boiler as well as a solar heating system, as it reduces the need for continuous stoking in the boiler. Whether this method is financially attractive depends on the price of firewood.

### **Geographical parameters**

Leaders in the EU are Greece and Austria with some 260 m<sup>2</sup>/1000 inhabitants, to Denmark with about 60 m<sup>2</sup>/1000 inhabitants. Israel probably has the highest penetration of solar thermals with about 740 m<sup>2</sup>/1000 inhabitants. In absolute terms, the European solar thermal market is dominated by Germany (50 %) followed by Greece and Austria (each 12 %).

### **Advantages**

- A solar heating system does not emit any CO<sub>2</sub> or other harmful substances to the atmosphere.
- When a solar heating system has been paid through savings on the heating bill, the sun supplies free heat year after year.
- A frequent criticism is that solar collectors disfigure buildings with their unattractive appearance. However, today, systems have been developed that are integrated into the roof surface in a harmonious way.

### **Disadvantages**

- A solar heating system in Europe can typically not stand alone, but has to be supplemented by another type of energy, because the sun does not shine continuously.
- Solar heating is presently more expensive than fossil energy.

### **Timeline**

- 2006: the technology is fully developed and ready. Continuous smaller efficiency improvements are expected. The technology is adequately covered in terms of norms and standards.
- 2004-2010: intermediate period for solar heating. Scattered distribution of inexpensive systems.
- 2005-2010: possibility of some distribution of cooling through solar heating of buildings.
- 2010-: good possibility of growing distribution to houses and buildings, in particular due to the EU Directive on Energy Consumption in Buildings. Presupposes subsidy scheme or rising oil and gas prices.
- 2015: 100 million m<sup>2</sup> installed.<sup>34</sup>

---

<sup>34</sup> Estimated by ESTIF – European Solar Thermal Industry Federation ([www.estif.org](http://www.estif.org)) – with support of active policies.

## **External expert comments**

### **Satu Helynen**

Utilisation of solar energy for heating provides a very efficient method of distributed utilisation of renewable energy. Specific investment costs can be very reasonable and operation and maintenance costs nearly negligible. In the worst case, this could lead to negative side effects like increased use of hot water in dry areas, if water is not priced according to its real costs.

Solar energy systems can be integrated into essential parts of building structures where also passive use of solar energy for heating is taken into account and, at the same time, the demand for cooling can be largely avoided. In most cases, right choices in the construction phase of the building give the best results, although the renovation and upgrading of heating systems in older buildings are important because of their significant superiority in numbers to new buildings.

Building regulations and other incentives of authorities are very important in order to put pressure on manufacturers and constructors to provide energy efficient solutions and to help consumers make the right choices.

## 8.2 Solar Energy – PV systems

### Technology information

Photovoltaic (PV) power systems convert light directly into electricity without any moving parts or any emissions, which means PV systems can normally – unless very little physical space is available – be implemented directly at the site of the electric load to be supplied, one of the great advantages of PV technology (on-site generation). R&D of PV technology has since the early 1970's been supported both on the EU level and by the EU member states, and the EU constitutes presently a centre of excellence in the field of PV technology. Although not yet competitive with other sources of electricity, PV is widely regarded as a significant contributor to the future electricity supply of Europe, and to stimulate this evolution, a PV Technology Platform was established in 2005 encompassing all important EU stakeholders.

Typical conversion efficiency for a Silicon PV module is 14-16 %, the best commercial modules exhibiting 20-21 % efficiency.

PV modules and systems are much better documented and tested than most other industrial products. The reason for this is that the technology was originally developed for space travel and military purposes, where it had to meet very strict requirements. Today, the main market is PV systems connected to the electric grid, but there is also a considerable market for stand-alone systems, in particular for remote professional applications such as signalling and telecom, water pumping, cathodic protection and similar. In developing countries, small stand-alone systems (Solar Home Systems) are used for household electrification outside the grid coverage.

The global market for traditional photovoltaics (PV) has in the last 5 years seen an annual rate of growth of about 40%. In 2004, the growth was more than 60%. And in 2005, about 43%. Even if the base in terms of energy production is quite small, the global PV market in 2005 exhibited a value of more than 12 billion €. The market is mainly traditional Silicon-based crystalline cells and modules. In 2005, almost 90% of the PV modules produced were based on crystalline Silicon technology, with poly-crystalline Silicon modules constituting about 60%. Since 2004, lack of Silicon feed-stock has led to an increase in PV module cost and a slight increase in system cost and this has established a real “sellers market”. Since 2005, the Silicon industry has invested heavily in increased production capacity and this feed-stock bottleneck is expected to be cleared during 2007-8. Crystalline Silicon cells and modules are expected to dominate the market in the coming 10-15 years and only after about 20 years are they expected to cover less than 50 pct. of the global PV market.

The EU has in 2005 launched a PV Technology Platform and regards PV as a significant future energy technology for the Union. The EU goal of reaching 3 GW installed PV capacity by 2010 (1% of the EU electricity consumption) is presently expected to be exceeded, as 4.5-5 GW installed capacity is regarded as realistic by 2010.

### Best available technology

A typical system for a one-family house that is self-sufficient with regard to electricity is of 15-35 m<sup>2</sup>, which corresponds to a power of 2-5 kW (depending on PV cell type). In northern Europe, a PV system can produce approx. 850-900 kWh/year for each kW of generating capacity; in southern Europe, almost the double. Recently, PV modules with efficiencies of more than 20% have been introduced onto the market – which means that the necessary solar cell area can be significantly reduced. On the installation side, there are now also so-called “plug-and-play” systems, which are plugged directly into the socket and thus displace purchased electricity.

Traditional PV technology has a learning curve typically showing a learning rate of some 20% , signifying a reduction in cost of 20% every time the volume is doubled. This trend is expected to continue for the next 10-15 years, as a combination of reduced material (Silicon) consumption and improved production technology will make this possible without any demand for “new technology”. Thin film PV module types with strongly reduced manufacturing costs are slowly gaining ground and will probably take a prominent position in the future. However, they still exhibit lower efficiency and lower stability compared to crystalline PV modules.

### **Supply potential**

A number of scenarios have been developed for future PV penetration in the EU and in the individual member countries. Maximum penetration foreseen up to 2040 ranges from between 20-40% of all electricity consumed. However, these forecasts are inherently very uncertain and depend very much on energy policies, raw material supplies, manufacturing capacities and in particular price developments.

It is relatively easy to forecast the production of electricity from PV systems and to integrate the electricity into a given electricity grid system. The main area of application in Europe appears to be building integrated PV systems (BIPV), where the PV technology can be applied in urban areas, not taking up new space, can easily be connected to the grid, is close to the actual consumption of electricity and can fulfil “multi-functions” in a building, e.g. be an integral part of the building envelope as well as produce electricity.

### **Environmental impact**

PV modules do not have any impact on the environment during operation. The total cradle-to-grave environmental impact of typical PV Silicon modules is very limited. Recycling of PV modules and the associated electronics is well-known and the possibilities are continuously being improved. Health and environmental issues related to PV technology are being studied and investigated internationally, e.g. in the framework of the International Energy Agency (IEA).

The consumption of energy for manufacturing a PV module will usually be produced by the module within approx. 3-4 years. The economic lifetime is typically 30 years or more. This means that the solar cells produce almost ten times as much energy as the amount of energy used for manufacturing and operating the solar cell system. If solar cells replace other building materials, the energy balance can become even better.

### **Technology lifetime**

The economic lifetime of present typical state-of-the art PV systems in Europe is 30 years. However, the PV modules themselves can be expected to last longer. On the other hand, PV technology develops quite quickly, and old installations may be considered obsolete earlier due to this technical progress.

### **Economy**

The cost of electricity from PV systems has to be reduced significantly to become a real alternative to electricity supply based on fossil fuels and thereby achieve a break-through in the energy sector. Since the beginning of the 1980s, the price of solar cell modules has been halved every 7 years. In Europe, the present cost of electricity from PV systems is around 0.3-0.4 €/kWh in northern Europe and half of that for the best systems in southern Europe. These costs can be reduced by increasing the efficiency of PV systems or by reducing the overall costs – both happen continuously through research and development in materials, processes, design, etc. At the same time, growing production volumes also lead to falling prices.

At present, PV systems are reported to be competitive as peak-load shaver in southern Europe. In general terms, PV systems are expected to be competitive in Europe inside 8-12 years.

### **Interaction with the energy system**

There seems to be little in terms of technical constraints even for a large-scale penetration of PV technology into a given grid system. There is normally good correlation between PV production and the need of electricity and PV production is relatively easy to forecast accurately. Many investigations have shown that modern inverter technology does not impair power quality – on the contrary.

### **Geographical parameters**

Europe exhibits considerable differences in insolation – in yearly average, a factor 1:2 from northern to southern Europe and, more importantly, a seasonal variation in the north of 1:10 compared to 1:4 in the south.

Besides the resource variations, the value of PV produced electricity differs considerably across Europe, depending on factors such as load profiles, type and operation of generators, tariff structures and cost of fuel.

### **Advantages**

- PV systems do not have any environmental impact during operation.
- PV systems constitute a robust and reliable type of energy production with few operating costs and a long lifespan.
- Power is produced during the day, when the demand is largest.
- PV systems are scale neutral in efficiency – small systems are as energy efficient as large systems
- A PV system consists of individual solar modules and can be expanded to MW or GW in system size – like building blocks, more solar modules can be put together to create a system theoretically endless in size<sup>35</sup>.
- PV systems are easy to adapt to the electrical power network, as decentralised as well as central production.
- There are good possibilities for integrating PV systems into the urban environment and into buildings.

### **Disadvantages**

- The price of a PV system is still relatively high, and the technology is not yet competitive with the alternatives supplying the electrical grid systems. However, prices are expected to fall continuously for quite a considerable time in the future and to reach competitiveness in about 10 years.

### **Timeline**

- 2005-2010: solar cells are more and more being architecturally integrated into buildings (BIPV), a trend also expected to be stimulated by the EU energy & building directive.

---

<sup>35</sup> Very Large Scale Photovoltaic Power Generations Systems (VLS-PV) are examined by IEA-PVPS <http://www.iea-pvps.org/tasks/task8.htm>

- 2010: Standard Silicon based PV module cost a < 1,5 €/W; increased area of competitiveness for PV electricity
- 2010: commercial break-through for third generation solar cells. This will result in integration of inexpensive solar cells in windows and many other building and consumer goods.
- 2015: standard Silicon PV module cost < 1€/W. PV systems play an important role in connection with solving peak load problems of the electrical power network.
- 2015-2020: solar cells are expected to be directly competitive to alternative electricity producing technologies.
- 2025: emergence of solar cells that have an integrated electrolysis function and can therefore produce hydrogen for use as a propellant in fuel cells.

### **External expert comments**

#### **Satu Helynen**

Utilisation of solar energy is one of the most feasible options for solving the environmental and availability problems connected to energy supply in the future. The potential is practically unlimited, but more innovations are needed for increased use of solar energy, to make it feasible also in developing countries.

Solar energy is utilised successfully in Finland in several niche markets, such as off-grid areas like mountains, islands and highways, and holiday houses where emission-free distributed electricity production is favoured.



# 9. Hydro Power

## Introduction to Hydro Power

The idea of harnessing the energy of water seems to have come to several different peoples at the same time. The earliest description of a watermill occurs in an account written in the late first century B.C. by the Greek geographer Strabo, describing the riches of King Mithradates of Pontus, on the Black Sea coast of Turkey.

In 1870, one started to exploit hydropower for the production of electricity and use it for lightning. In 1973, the electricity generation from hydro was 21% of the total electricity generation of the world. By 2004, it had been reduced to 16% of the total generation but it contributed with 2808 TWh/year.<sup>36</sup> The EU-25 electricity production was 3039 TWh in 2005. The hydropower share was 10 % or 311 TWh.

Sweden	France	Italy	Austria	Germany	Spain	Finland
Production of hydropower in 2005 (TWh)						
72.1	56.0	41.7	37.0	27.7	22.7	13.6
Production of hydropower in 2005, % of hydropower production in EU-25						
23 %	18 %	13 %	12 %	9 %	7 %	4 %
Economically exploitable capability at end of 1999, TWh/year <sup>37</sup>						
90	70	65	56	20	41	20

## Technology information

Water flow and head of water determine the potential energy of a waterfall. The head of water is the height difference between reservoir intake and power station outlet. Water is directed into pressure shafts leading down to a power station, where it strikes the turbine runner at high pressure. The kinetic energy of the water is transmitted via the propeller shaft to a generator, which converts it into electrical energy. We have in question two types of hydropower stations: low-head and high-head power stations:

*Low-head power stations* often utilise a large water volume but have a small head, as in a run-of-river power station. Since regulating the flow of water is difficult, it is generally used as and when available. The amount of electricity generated therefore increases considerably when the river is carrying more water during the spring thaw or when precipitation is very high. Most run-of-river power stations are situated in lowland areas.

*High-head power stations* are generally constructed to utilise a large head but smaller volume of water than run-of-river installations. Many of this type of power stations store water in reservoirs and are referred to as power stations with reservoirs. The reservoirs allow water to be retained in flood periods and be released in drought periods, typically in the winter. Reservoirs allow a larger proportion of runoff to be used in power production. They usually have a larger installed capacity than run-of-river stations, but a shorter utilisation period. High-head power stations are often excavated near the reservoirs used to regulate the volume of their water supply. Power stations and reservoirs are connected by tunnels through the rock or pipes down the mountainside.

The potential energy of water can be stored in regulation reservoirs constructed either in natural lakes or in artificial basins created by damming a river. Water is collected in the regulation reservoirs when inflow is high and consumption low. When inflow is low and consumption high,

<sup>36</sup> IEA, Key World Energy Statistics 2006.

<sup>37</sup> WEC Survey Of Energy Resources 2001 - Hydropower

stored water can be drawn from the reservoirs and used to generate electricity. Regulation reservoirs are generally situated in sparsely populated areas, and usually at high altitudes in the mountains in order to make the fullest possible use of the head of water. Storing water in the wet season for use in the dry season, when the demand for power often peaks, is known as seasonal regulation. Dry- or multi-year regulation is made possible by large reservoirs, which can store water in wet years for use in years when precipitation is low. Short-term regulation to meet the variation in consumption and of the unregulated power production, can involve a daily or weekly filling and emptying cycle in the hydropower stations with reservoirs.

Small power stations have now a political priority in the EU. They are often installed on streams and small rivers without regulation reservoirs. Their output will then vary with the level of water flow.

Hydropower is a mature technology with a high level of efficiency but there is an ongoing R&D to increase the total efficiency and reduce the construction cost of hydropower plants.

### **Best Available Technology**

Technology for hydropower construction and mechanical and electrical equipment is very different between small and large hydros, and the large hydro has always been the driving force behind technology development. For example, the X-blade turbine, which was designed for the large hydro, is available also for the small hydro, pushing the efficiency for turbines to over 95%. There are different technologies for low, medium and high head plants and also for small and large plants. Kaplan turbines are used for low head, Francis turbines for medium to high head (up to approximately 700 m head) and Pelton turbines for the very high head up to 2400 m. The size of the plants decides the type of turbine and the lowest head. The smallest Small hydro can have Francis from approximately 6 m head and Pelton from approximately 30 m head. Only hydros with reservoir capacity can generate firm power and peak power.

Normal definition of a Small Hydro is between 0 and 10 000 kW, because smallest units technology must focus on low prices rather than high efficiency. Small hydros are often run off river plants with limited reservoir capacity, but there are examples of one year reservoir capacity also in the case of small hydros. The high head small hydro has traditionally been characterised by a penstock on the hillside. New technology will introduce economically viable underground plants also for small hydros. New technology for small hydros allows the owner to operate the plant by using his cell phone and combining information on weather forecasts and spot market prices for optimum generation throughout the day and week.

### **Environmental impact**

Production of hydropower is free of emissions or waste products, but may have negative influences on the landscape and especially on the local eco-system of river systems. The local eco-system of river systems is one of the most important topics in the current debate concerning the use or construction of hydropower in Europe. The EU Water Framework Directive is a new ecological orientation of European water policy. Social and environmental impacts of hydro development can cause problems, but can also be power boosting to the local economy without causing undue encroachment on the environment. A modern scheme will, for instance, leave water in the river or have by-pass channels for fish migration and can be designed to meet the needs of different user groups.

### **Economy**

The cost of hydropower depends largely on the site, the amount of water and the waterfall (head). It can range from below 0.01 €/kWh (rate of interest 6.5%, economic lifetime 40 years and running

cost 1% of the investments). Upwards, the cost depends on the increasing marginal cost when the project is expanded, environmental restrictions and the marginal value of the increased production in the power market. Implementation of the Water Directive will result in additional costs and perhaps in operational restrictions for hydropower plants.

### **Technology lifetime**

The economic lifetime of a hydropower plant is often set at 40 years. The technical lifetime depends on which part of the power plant is focused on. The lifetime of the buildings, dams or tunnels is far beyond 60 years.

### **Interaction with the energy system**

The large hydro has the ability to reduce the need for spinning reserve in a thermal system or a system dominated by unregulated power production. Hydropower plants with reservoir capacity have peak power capacity either as pump storage plants, or in their ability to quickly switch the generators on or off, or to change production in order to follow the system load.

### **Advantages**

- No emissions or waste products during production.
- Low operating cost, 0,002-0,005 €/kWh.
- Long plant life.
- Can have a multi-purpose character when built with reservoir: reduction of inundation, irrigation.
- Easy to regulate and fast response time; peak power production and load following.
- Can “store energy” either by building a pumped-storage power plant or by not withdrawing water from reservoirs during periods with much unregulated production.
- Use of local labour during the construction period.
- Proven and advanced technology.

### **Disadvantages**

- Visual impact of constructions and empty riverbeds.
- Local ecological impact.
- Social impact of using area for hydropower production, for example when building reservoirs.
- Run-of-river power plants depend on the water inflow.

### **Timeline**

- 2006: the technology is highly dependent on natural conditions and, with the new Water Directive, it is impossible to predict the future of new large scale hydropower.
- Future: there are some hydropower projects that have a big chance of being completed: Run-of-river projects, Hydropower plants that utilise existing dams and reservoirs and Small-scale schemes.

## External expert comments

### **Satu Helynen**

Hydropower has been the basis of industrialisation in remote and isolated villages, in Finland for instance. Saw and paper mills, metal and other industries were built around hydropower plants that generated power for industrial processes before electricity grids were built. Presently, hydropower offers both a very low-cost base load production and also efficient production to cover peak loads, so hydropower can be regarded as the most valuable part of the electricity system in Finland.

Possibilities of building new hydropower plants are very limited in most European countries. But implementation of new technology for turbines, generators and additional equipment for the renovation of hydropower plants can result in several percentages more electricity than before. Greatest benefits have been gained in smaller scale plants in Finland. Upgrading of hydropower plants can also include new dam structures, additional reservoirs and increased use of flood peaks, which could increase the capacity of the whole water system considerably. At the same time, negative environmental effects can be reduced and the recreational value of water systems can be increased.

# 10. Fuel cells

## Introduction to fuel cells

A fuel cell converts energy from one energy carrier - hydrogen or a hydrogen rich fuel – to another energy carrier – electricity – directly by electro-chemical process with well controlled oxidation ('combustion'), minimal environmental intrusion and no moving parts. The fuel cell process was first demonstrated in 1839 (by Grove). So, it is no new technology, but it has only recently been developed into a practical technology. Developments over the past decade indicate that the technology will become fully competitive in selected application areas within the next decade. Compared to competing technologies (e.g. internal combustion engines), fuel cell technology provides a huge potential for increasing energy efficiency and reducing environmental pollution.

## Technology information

A fuel cell consists of two catalytical electrodes (the anode and the cathode) with an electrolyte (the membrane) in between. The hydrogen rich fuel is fed to the anode (the negative electrode), while oxygen (air) is fed to the cathode (the positive electrode). Depending on the electrodes and the electrolyte, either hydrogen ions ( $H^+$ ) travel from the anode or oxygen ions ( $O^-$ ) travel from the cathode through the electrolyte, the hydrogen reacts with the oxygen and becomes water ( $H_2O$ ), while producing heat and electricity. The process is shown in the figure on the following page. Fuel cells can operate on a variety of fuels, and their applications and deployment are not linked to the development of hydrogen as an energy carrier (the "hydrogen society"). Fuels with bound hydrogen<sup>38</sup> must be reformed into free hydrogen either by a separate pre-reformer unit or by catalytic process at the anode as an integral part of the fuel cell.

The power capacity is proportional to the reaction area and inversely proportional to the distance between the electrodes. Fuel cells are thus usually designed as flat sandwich with plate electrodes and thin electrolyte membrane. The maximal electrical current density is typically  $1 \text{ A/cm}^2$  and the voltage  $0.7 \text{ V}$  per cell. The cells are usually stacked and coupled in series to obtain higher stack voltage. The stacks must be designed to allow air flow to and from the electrodes. The realistic electrical efficiencies are typically 30-50% - with the remaining energy converted to heat.

Different fuel cell technologies have different characteristics, suitable for different applications. Roughly, the technologies may be divided into low temperature and high temperature fuel cells. The low temperature fuel cells (50-150C) are characterised by their simple operation, very critical to the purity of the hydrogen fuel, and problems with condensation of the water exhaust; they are closest to becoming commercially suitable for dynamic operations and mobile applications.

The high temperature fuel cells (600-1000C) are characterised by their more complicated operation at high temperatures, higher electricity efficiency, greater flexibility with regard to fuel mix and water vapour exhaust; they are best suited to steady operations and stationary applications.

But new fuel cell types are constantly being developed, combining the characteristics. The following are some of the fuel cell technologies (their names are defined by their electrolytes): PEM – proton exchange membrane (or polymer electrolyte membrane) fuel cells, AFC – alkaline fuel cells, PAFC – phosphoric acid fuel cells, SOFC – solid oxide fuel cells, MCFC – molten carbonate fuel cells, DMFC – direct methanol fuel cells.

---

<sup>38</sup> E.g. methane ( $CH_4$ ), methanol ( $CH_3OH$ ), ammonia ( $NH_3$ ) or the NG mix.

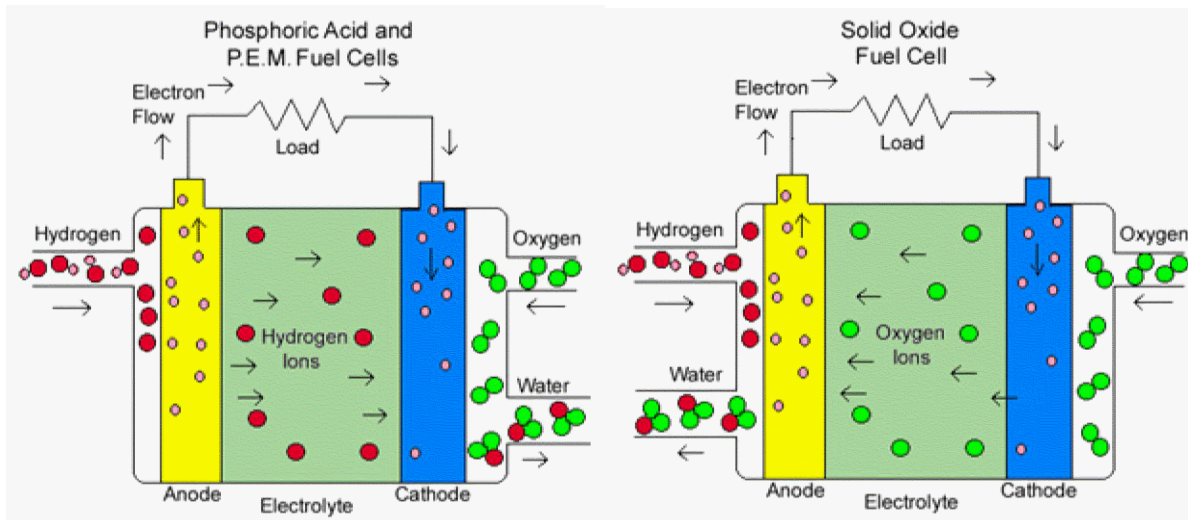

The efficiency of fuel cells is little dependent on scale and fuel cells are used in applications from mW to MW scales – in vehicles and trains, auxiliary power supply units, combined heat and power units, etc. High temperature fuel cells may be combined with gas turbines (hybrid systems) to achieve a higher overall electricity efficiency.

In principle, fuel cells can operate in reverse as electrolyzers, producing hydrogen and oxygen on the basis of electricity consumption. In practise, the units are designed and optimised either as fuels cells or as electrolyzers. Prototype electrolyser units indicate interesting characteristics with very high efficiencies, but they are not yet commercially available.

### **Best available technology**

The term “fuel cell” covers as mentioned above a number of different technologies with different characteristics. The best available technology depends on the actual application and priorities such as price, efficiency, robustness, fuel flexibility, dynamic properties, lifetime, size, weight, etc. All fuel cell technologies are still in the very first phases of development and many of the technologies are not yet commercially available.

### **Supply potential**

The fuel cell’s contribution to the energy system in the coming decades will probably mostly be in the form of combined heat and power generating units (CHP) based on natural gas.

### **Environmental impact**

The environmental impact of fuel cells depends mostly on how the fuel is produced and provided. If the fuel produced is based on fossil fuel, the fuel cell technology in itself provides no sustainable solution. Conversion of fuel in fuel cells can be a very clean process compared to other combustion processes. Besides water, the by-products depend mainly on the fuel and may still include CO<sub>2</sub>

### **Technology lifetime**

The cell’s lifetime is one of the crucial problems with fuel cells, but if development trends from past years continue – typically more than doubling each year – the lifetime will become more competitive within the next decade. Lifetimes of 10,000 operation hours have been demonstrated in 2006.

## **Economy**

The price of fuel cells is another crucial factor in the deployment of technologies. Therefore, fuel cells will first be seen in applications prioritising qualities other than the price, or applications with little impact on the energy system – e.g. auxiliary power systems.

## **Interaction with energy system**

Fuel cells used in Combined Heat and Power Plants (CHP) and – in a longer perspective – in automotive applications will increase both the overall energy efficiency and the flexibility of energy systems – a flexibility that is necessary for large-scale integration of intermittent renewable energy resources.

## **Geographical parameters**

The combination of scale and fuel flexibilities makes fuel cells widely usable.

## **Advantages**

- High electricity efficiency (50-60%) – in hybrid combination up till 70%.
- High scale flexibility (from mW to MW), maintaining the same characteristics.
- High fuel flexibility – in principle, all hydrogen rich fuels, but with varying available maximum electricity efficiencies.
- Potential for high reliability, with few moving parts and high control of the chemical reactions.
- Low pollution emission – low NO<sub>x</sub>, SO<sub>x</sub> etc.
- Low noise emission – allows for application in noise-critical environments.

## **Disadvantages**

- High cost – from 10 €/W (2006).
- Relatively high size and weight (compared to internal combustion engines).
- Long start-up time – typically 10-60 minutes depending on the type of fuel cell.
- Still has a short lifetime – but 10,000 operation hours have been demonstrated.

## **Timeline**

- 2006: the first small-scale fuel cell applications are now commercially available on the international market and a huge number of different perspective (but still not competitive) pilot projects are being established worldwide.
- 2010: fuel cells in auxiliary power systems are expected to have become competitive.
- 2015: CHP applications are expected to have become competitive.
- 2020: automotive applications are expected to have become competitive.

## **External expert comments**

### **Satu Helynen**

Fuel cells produce electricity and heat with negligible environmental effects on site, with very high power-to-heat ratios in CHP units, and production units can have a very large capacity range from microwatts for portable devices to megawatts. Developments aimed at reducing specific investment costs will continue for a long time; an intensive learning process has just started, but new niche products will continuously be launched – and have already been launched – to special market

segments that are able to accept high investment costs because of the above-mentioned benefits. Mass production of fuel cells – as in the field of PV systems – could cause dramatic cost reductions.

The total efficiency and environmental benefits of fuel cells requires careful assessment of the whole chain where the efficiency of hydrogen or methane production is essential. Biomass-based methane transported in natural gas networks and fuel cell plants in buildings providing heating and electricity could be one vision for many densely populated countries for using renewable energy efficiently.



# 11. Comparison of scopes of application

The table below shows the scopes of application for the various technologies; what they can be used for and how large a scale we are dealing with.

Technology:	Use:				Scale:			
	Electricity	Heating	Transport	Storage	Micro	Small	Medium	Large
Solar - SHW		x				X	x	x
Solar - PV	x				x	X	x	x
Geothermal <sup>39</sup>	x	x		x			x	x
Wind	x	x				X	x	x
Wave	X							X
Biogas plants	X	x	x	x			x	x
Biomass powered heat and power stations	X	x		x			x	x
Bio ethanol systems			x	x				
Fuel cells	X	x	x		x	X	x	
Hydro power	x			x	x	X	x	x

---

<sup>39</sup> Geothermal energy from the Earth's interior produced through deep wells



## 12. Comparison of price levels

The table below shows estimated production prices in 2006. All prices are stated in Euro to make them comparable.

Technology	Production price
Wind energy	0.033-0.040 €/kWh
Wave energy	0.30 - 0.33 €/kWh
Geothermal energy <sup>40</sup>	0.022 - 0.044 €/kWh
Bioenergy - biogas plants	0.06 - 0.12 €/kWh
Bioenergy - biomasspowered heat and power stations	0.07 - 0.20 €/kWh
Bioenergy - bioethanol systems	1st. generation: 0.1 €/kWh 2nd generation: 0.05 -0.08 €/kWh.
Solar energy - SHW	0.12-0.18 €/kWh
Solar energy - PV <sup>41</sup>	0.25-0.60 €/kWh
Hydro power <sup>42</sup>	From 0,01 €/kWh
Fuel cells	To early to estimate price

### Comment regarding prices

The production costs include the interest and repayment of investment costs relevant to the technology. A common interest rate and depreciation period has not been used as different technologies and projects do not have the same risk factors and lifetime expectancy. The price ranges are intended to represent "normal" levels, but actual costs depend on local conditions.

---

<sup>40</sup> [Geothermal heat production to district heating networks in areas with normal temperature gradients](#)

<sup>41</sup> Regarding both SHW and PV: the price is lower in southern Europe than in northern Europe.

<sup>42</sup> Rate of interest 6.5%, economic lifetime 40 years and running cost 1% of investments.



## 13. Consumption of sustainable energy in Europe

The table below shows the consumption of sustainable energy and per cent of total energy consumption. Information covers each European country and Europe in total. Not all energy sources presented in this catalogue are shown due to the lack of Eurostat data.

### Gross Inland Consumption from Renewables and Share on Total Gross Inland Consumption

	Total (ktoe)	Hydro (ktoe)	Biomass (ktoe)	Other (ktoe)	Share (%)
<b>BE</b>	1161	27	1119	15	2,1
<b>CZ</b>	1363	174	1188	1	3,1
<b>DK</b>	2926	2	2346	577	14,6
<b>DE</b>	13755	1812	9367	2576	4
<b>EE</b>	607	2	604	1	10,8
<b>EL</b>	1560	402	953	205	5,1
<b>ES</b>	8977	2713	4853	1411	6,4
<b>FR</b>	17304	5179	11927	198	6,3
<b>IE</b>	325	54	214	56	2,1
<b>IT</b>	12528	3671	3791	5066	6,8
<b>CY</b>	97	-	5	92	3,9
<b>LV</b>	1649	267	1377	4	35,9
<b>LT</b>	734	36	698	-	8
<b>LU</b>	73	9	59	4	1,6
<b>HU</b>	965	18	860	88	3,7
<b>MT</b>	-	-	-	-	-
<b>NL</b>	2364	8	2175	181	2,9
<b>AT</b>	6766	3132	3450	184	20,7
<b>PL</b>	4325	179	4126	20	4,7
<b>PT</b>	3894	849	2877	169	14,9
<b>SI</b>	822	352	470	-	11,6
<b>SK</b>	392	353	35	5	2,2
<b>FI</b>	8805	1296	7498	11	23,4
<b>SE</b>	14131	5170	8883	78	26,6
<b>UK</b>	3671	424	3055	192	1,6
<b>EU-15</b>	98240	24748	62567	10925	6,4
<b>EU-25</b>	109194	26128	71929	11136	6,3
<b>IS</b>	2519	613	2	1904	72,3
<b>NO</b>	10697	9353	1322	22	38,7
<b>BG</b>	980	272	708	-	5,2
<b>HR</b>	977	598	379	-	11
<b>RO</b>	4634	1420	3134	80	11,7
<b>TR</b>	10783	3963	5550	1271	13,2

Data Source: Eurostat



## 14. Energy authorities in Europe

The list below shows the energy organizations in Europe, which can help with information and contact to relevant organizations within the sustainable energy sources and technologies presented in this catalogue. All organisations listed below are members of the European Energy Network, which is voluntary for organizations having a responsibility for the planning, management or review of national research, development, demonstration or dissemination programmes in the fields of energy efficiency and renewable energy. Not all energy authorities in Europe are presented but only members of the European Energy Network are listed below.

### **Austria**

Österreichische Energieagentur - Austrian Energy Agency  
Otto-Bauer-Gasse 6  
1060 Wien  
Austria

Tel: (+43) 1 586 15 24 - 0  
Fax: (+43) 1 586 15 24 - 40  
[office@energyagency.at](mailto:office@energyagency.at)  
[www.energyagency.at](http://www.energyagency.at)

### **Croatia**

Energetski institut Hrvoje Požar  
Savska cesta 163  
P.B. 141, 10001 Zagreb  
Croatia

Tel: (+385) 1 6326-100  
Fax: (+385) 1 6040-599  
[eihp@eihp.hr](mailto:eihp@eihp.hr)  
[www.eihp.hr](http://www.eihp.hr)

### **Denmark**

Danish Energy Authority  
Amaliegade 44  
DK-1256 Copenhagen K

Tel: (+45) 33 92 67 00  
Fax: (+45) 33 11 47 43  
[ens@ens.dk](mailto:ens@ens.dk)  
[www.ens.dk](http://www.ens.dk)

**Finland**

Motiva  
P.O. Box 489  
FIN-00101 HELSINKI  
Urho Kekkosen katu 4-6 A, 6th floor  
Helsinki

Tel: (+358) 9 8565 3100

Fax: (+358) 9 8565 3199

[motiva@motiva.fi](mailto:motiva@motiva.fi)

[www.motiva.fi](http://www.motiva.fi)

**France**

ADEME (European Affairs)  
27 rue Louis Vicat  
75737 Paris Cedex 15  
France

Tel: +33 1 47 65 24 86

Fax: +33 1 46 38 31 41

[www.adem.fr](http://www.adem.fr)

**Germany**

Deutsche Energie-Agentur Gmbh  
(dena) – the German Energy Agency  
Chausseestrasse 128a  
10115 Berlin  
Germany

Phone: +49(0)30726155-600

Fax: +49(0)30726465-699

[info@dena.de](mailto:info@dena.de)

[www.dena.de](http://www.dena.de)

**Greece**

Center for Renewable Energy Sources - CRES  
19th km Marathonos Ave  
19009, Pikermi Attiki  
Greece

Tel: (+30) 210 6603300

Fax: (+30) 210 6603301/302

[cres@cres.gr](mailto:cres@cres.gr)

[www.cres.gr](http://www.cres.gr)



**Ireland**

Sustainable Energy Ireland  
Glasnevin  
Dublin 9

Tel: (+353) 18369080  
Fax: (+353) 1 8372848  
[www.sei.ie](http://www.sei.ie)

**Italy**

Ente per le Nuove tecnologie l'Energia e l'Ambiente (ENEA)  
Lungotevere Thaon di Revel 76  
00196 Rome

Tel: (+39) 06 36271  
Fax: (+39) 06 36272591/2777  
[www.enea.it](http://www.enea.it)

**Luxemburg**

Agence de l'Energie S.A. (AEL)  
4-6, rue du Fort Bourbon  
L-1249 Luxembourg

Tel: +352 40 65 64  
Fax: +352 40 87 68  
[contact@ael.lu](mailto:contact@ael.lu)  
[www.ael.lu](http://www.ael.lu)

**Netherlands**

SenterNovem  
Postal address:  
P.O. Box 93144  
2509 AC The Hague, The Netherlands

Tel: +31 30 239 35 33  
[frontoffice@senternovem.nl](mailto:frontoffice@senternovem.nl)  
[www.senternovem.nl](http://www.senternovem.nl)

**Norway**

Enova SF  
Abelsgate 5  
N-7030 Trondheim  
Norway

Phone: +47 73 19 04 30

Fax: +47 73 19 04 31

[www.enova.no](http://www.enova.no)

**Poland**

The Polish National Energy Conservation Agency (Kape)  
35, Mokotowska St.  
00-560 Warsaw

Tel: (+48) 22 626-09-10

Fax: (+48) 22 626-09-11

[kape@kape.gov.pl](mailto:kape@kape.gov.pl)

[www.kape.gov.pl](http://www.kape.gov.pl)

**Portugal**

Agência para a Energia - ADENE  
Estrada de Alfragide  
Pcta. 1, nº 47 2610-181 AMADORA

Tel.: (+351) 214 722 840

Fax: (+351) 214 722 898

[info@adene.pt](mailto:info@adene.pt)

[www.adene.pt](http://www.adene.pt)

**Slovakia**

Slovenská energetická agentúra  
Directorate  
Bajkalská 27  
827 99 Bratislava 27

Tel.: (+421) (2) 58248 111

Fax: (+421) (2) 5342 1019

[office@sea.gov.sk](mailto:office@sea.gov.sk)

[www.sea.gov.sk](http://www.sea.gov.sk)

**Slovenia**

Sektor za aktivnosti učinkovite rabe in obnovljivih virov energije  
Dimičeva 12  
1000 Ljubljana  
Slovenia

Tel: (+386) 01/ 300 69 90  
Fax: (+386) 01/ 300 69 91,  
[info.aure@gov.si](mailto:info.aure@gov.si)  
[www.aure.si](http://www.aure.si)

**Spain**

Institute for Energy Diversification and Saving  
C/Madera, 8  
28004 MADRID

Tel: (+34) 91 456 49 00  
Fax: (+34) 91 523 04 14  
[comunicacion@idaes.es](mailto:comunicacion@idaes.es)  
[www.idaes.es](http://www.idaes.es)

**Sweden**

Kungsgatan 43  
Postal Address:  
Box 310  
631 04 Eskilstuna

Tel: +46 16-544 2000  
Fax: +46 16-544 2099  
[registrator@energimyndigheten.se](mailto:registrator@energimyndigheten.se)  
[www.stem.se](http://www.stem.se)

**United Kingdom**

Energy savings trust  
21 Dartmouth Street,  
London SW1H 9BP

Tel: 020 7222 0101  
Fax: 020 7654 2460  
[www.est.org.uk](http://www.est.org.uk)

**Bulgaria**

The Energy Efficiency Agency  
1000 Sofia  
37, Ekzarh Josif str., 4th Floor

Tel./fax: (+359) (02) 981 58 02  
[www.seea.org.bg](http://www.seea.org.bg)

**Czech Republic**

Česká energetická agentura  
Vinohradská 8  
120 00 Praha 2

Tel.: (+420) 257 099 011  
Fax: (+420) 257 530 478  
[cea@ceacr.cz](mailto:cea@ceacr.cz)  
[www.ceacr.cz](http://www.ceacr.cz)

**Romania**

Romanian Agency for Energy Conservation  
16 Blvd. Nicolae Balcescu  
Sector 1  
Bucharest  
Romania

Tel: (+40) 1 314 5929  
Fax: (+40) 1 312 3197  
[www.arceonline.ro](http://www.arceonline.ro)

## 15. Energy unit conversion table

The table below is a conversion table for different units of measurement for energy:

1 kilo Joule	=	1000 J
1 Mega Joule	=	1000 kJ
1 Giga Joule	=	1000 MJ
1 Terta Joule	=	1000 GJ
1 Peta Joule	=	1000 TJ
1 kWh	=	3,6 MJ
1 MWh	=	3,6 GJ
1 GWh	=	3,6 TJ
1 Btu (British thermal unit)	=	1056,66 J
1 bbl (barrel)	=	158 L
1 ktoe	=	41,868 TJ
1 mtoe	=	41,868 PJ



## 16. References and links

### **The Energy System:**

- EU Commission - [http://ec.europa.eu/energy/index\\_en.html](http://ec.europa.eu/energy/index_en.html)
- ECEEE – European Council for an Energy Efficient Economy – [www.eceee.org](http://www.eceee.org)
- Doing more with less, Green Paper on Energy Efficiency”, COM(2005) 265 final of 22 June 2005. [http://ec.europa.eu/energy/efficiency/doc/2005\\_06\\_green\\_paper\\_book\\_en.pdf](http://ec.europa.eu/energy/efficiency/doc/2005_06_green_paper_book_en.pdf)
- Eurima – [www.eurima.org](http://www.eurima.org)
- EuroACE - [www.euroace.org](http://www.euroace.org)

### **Wind energy**

- Wind Force 12, Final Report. GWEC, 2005
- Wind Energy thematic network
- European Wind Atlas
- World Market Update 2005, BTM Consult ApS, March 2006
- EU Green Paper on the security of energy supplies (2001)
- EU Directive on the promotion of electricity from renewable energy sources (2001) COM(2004) 366
- IEA Wind Energy Annual Report 2005, International Energy Agency, June 2006
- [www.ewea.org](http://www.ewea.org)
- [www.eurec.be](http://www.eurec.be)
- [www.europarl.eu.int/stoa.default](http://www.europarl.eu.int/stoa.default)

### **Wave Energy**

- Implementing Agreement on Ocean Energy, IEA: [www.iea-oceans.org](http://www.iea-oceans.org).
- Co-ordinated Action on Ocean Energy. CA-OE: [www.CA-OE.net](http://www.CA-OE.net).
- Wave Dragon, [www.wavedragon.net](http://www.wavedragon.net).
- Wave Star, [www.wavestarenergy.com](http://www.wavestarenergy.com).
- Pelamis, [www.oceanpd.com](http://www.oceanpd.com).
- Archimedes Waveswing, [www.waveswing.com](http://www.waveswing.com).
- Wave Bob, [www.clearpower.ie](http://www.clearpower.ie).
- Power Buoy, [www.oceanpowertechnologies.com](http://www.oceanpowertechnologies.com).

### **Geothermal energy**

- Most useful information can be found on the internet, e.g. searching for “+geothermal +iga” (IGA = International Geothermal Association).

- [Http://geothermal.stanford.edu/standard/](http://geothermal.stanford.edu/standard/) (Information about the World Geothermal Congress held each 5 years with country updates, regional information and technical papers, etc.)
- [www.geotermie.de](http://www.geotermie.de) (the German Geothermal Association)
- [www.iga.com](http://www.iga.com)
- Atlas of Geothermal Resources in Europe - European Commission 2002

## **Bioenergy**

### Links:

- Biomass – Green energy for Europe – European Commission, Directorate-General for Research, 2005.
- Biofuels in the European Union, A vision for 2030 and beyond – European Commission, Directorate-General for Research, 2006.

### Links/Biogas plants:

- IEA bioenergy. Energy from Biogas and Landfill gas - [www.iea-biogas.net](http://www.iea-biogas.net)
- German Biogas Association – [www.biogas.org](http://www.biogas.org)
- Danish Biogas Association – [www.biogasbranchen.dk](http://www.biogasbranchen.dk)
- Swedish Biogas Association – [www.sbgf.org](http://www.sbgf.org)
- Austrian Compost and Biogas Association - [www.kompost-biogas.info](http://www.kompost-biogas.info)
- European Commission on renewable energy - [http://ec.europa.eu/energy/res/sectors/bioenergy\\_en.htm](http://ec.europa.eu/energy/res/sectors/bioenergy_en.htm)

### Links/Biomass-powered heat and power plants:

- IEA Bioenergy Task 32 – Biomass Combustion and Co-firing – [www.ieabcc.nl](http://www.ieabcc.nl)
- European Commission on renewable energy - [http://ec.europa.eu/energy/res/sectors/bioenergy\\_en.htm](http://ec.europa.eu/energy/res/sectors/bioenergy_en.htm)
- Integrated Biomass Utilisation System (IBUS) – [www.bioethanol.info](http://www.bioethanol.info)
- Avedøre II straw firing CHP plant – [www.e2.dk](http://www.e2.dk)
- Sanguesa straw firing CHP plant - <http://www.acciona-energia.com/default.asp>

### Links/Biofuel systems:

- European Bioethanol Fuel Association – [www.ebio.org](http://www.ebio.org)
- Swedish Bio Alcohol Fuel Foundation – [www.baff.info](http://www.baff.info)
- IEA Bioenergy Task 39 – Liquid Biofuels from Biomass – [www.task39.org](http://www.task39.org)
- European Commission on renewable energy - [http://ec.europa.eu/energy/res/sectors/bioenergy\\_en.htm](http://ec.europa.eu/energy/res/sectors/bioenergy_en.htm)
- Integrated Biomass Utilisation System (IBUS) – [www.bioethanol.info](http://www.bioethanol.info)
- Etek Etanolteknik AB – [www.etek.se](http://www.etek.se)
- New Improvements for Lignocellulose Ethanol (NILE) – [www.nile-bioethanol.org](http://www.nile-bioethanol.org)
- Elsam A/S – [www.elsam.com](http://www.elsam.com)
- Global potential bioethanol production from wasted crops and crop residues. Kim, S., Dale, B.E. (2004), Biomass and Bioenergy, 26, 361-375.
- British Association for Biofuel and Oils - [www.biodiesel.co.uk](http://www.biodiesel.co.uk)



- Austrian Biofuels Institute - [www.biodiesel.at](http://www.biodiesel.at)
- European Biodiesel Board - [www.ebb-eu.org](http://www.ebb-eu.org)
- Union zur Förderung von Oel- und Proteinpflanzen e.V. - [www.ufob.de](http://www.ufob.de)

## **Solar Energy**

- [www.erec.org](http://www.erec.org)
- [www.iea-shc.org](http://www.iea-shc.org)
- [www.iea-pvps.org](http://www.iea-pvps.org)
- [www.estif.org](http://www.estif.org)
- [www.epia.org](http://www.epia.org)

## **Hydro Power**

- Hydro power development, Norwegian University of Science and Technology, Department of Hydraulic and Environmental Engineering. ISBN 82-7598-025-9.
- Hydropower and the World's Energy Future, The International Hydropower Association (IHA) and Implementing Agreement on Hydropower Technologies and Program of International Energy Agency (IEA-HA), November 2000.
- [www.ieahydro.org/reports/Hydrofut.pdf](http://www.ieahydro.org/reports/Hydrofut.pdf).
- New constraints on hydropower, Hans Haider, President Eurelectric. [www.worldenergy.org/wec-geis/publications/ger/europe.asp](http://www.worldenergy.org/wec-geis/publications/ger/europe.asp)
- Climate change, emissions trading and hydropower, British Hydropower Association, October 2005. [www.british-hydro.org/Climate%20Change%20&%20Hydropower.pdf](http://www.british-hydro.org/Climate%20Change%20&%20Hydropower.pdf)
- Key World Energy Statistics, International Energy Agency, 2006. [www.iea.org/Textbase/publications/index.asp](http://www.iea.org/Textbase/publications/index.asp).
- Survey of Energy resources, World Energy Council. [www.worldenergy.org/wec-geis/publications/reports/ser/overview.asp](http://www.worldenergy.org/wec-geis/publications/reports/ser/overview.asp).
- IEA Hydropower Implementing Agreement. [www.ieahydro.org/agreement.htm](http://www.ieahydro.org/agreement.htm).
- Industry Statistics for electricity, Eurelectric, 2006. <http://public.eurelectric.org/Content/Default.asp?PageID=460>

## **Fuel cells**

- [www.fuelcellworld.org](http://www.fuelcellworld.org)
- [www.ansaldofuelcells.com](http://www.ansaldofuelcells.com)
- [www.fuelcellenergy.com](http://www.fuelcellenergy.com)
- [www.ird.dk](http://www.ird.dk)
- [www.powergeneration.siemens.com/en/fuelcells](http://www.powergeneration.siemens.com/en/fuelcells)
- [www.risoe.dk](http://www.risoe.dk)